

# solo<sup>®</sup>

**644 // 651 / 651H / 651SP // 656 / 656H / 656SP**

*Instruction manual*

**Chain saw**

***Important!***

Read this instruction manual carefully before first operation and strictly observe the safety regulations!



Dear Customer,

Congratulations for choosing this SOLO quality product.

SOLO have pioneered the development of the chainsaw in Germany. As one of the oldest manufacturers of petrol driven chainsaws in the business, they can fall back on a wealth of experience which informs every detail of a modern SOLO chainsaw.

The combination of state-of-the-art production materials with SOLO expertise guarantees that every machine offers an extremely long tool life and very high practical value.

The different models available in this range are particularly high quality chainsaws which are designed and built in Germany to meet the tough demands of professional use. A newly developed one-cylinder two-stroke high performance engine with an upright, nicasil coated cylinder uses conventional four-port technology to deliver exceptional power with very low fuel consumption, ensuring that the machine has a very high utility value.

- The **automatic chain lubrication** (Eco-matic),
- the **maintenance-free electronic ignition**,
- the **anti-vibration-system** which helps to prevent injuries,
- the intelligent solutions which offer particularly good **starting characteristics** and
- the **ergonomic design** of the overall machine

make it a dream to use in terms of its exceptional comfort and the way it doesn't tire you out when you are using the saw.

The safety equipment is state-of-the-art and complies with all German and international safety regulations. It includes

- **hand protection equipments** for both handles,
- **throttle control lock**,
- **chain guard plate**,
- low-kickback **safety saw chain** and
- the **chain brake** which can either be activated manually or responds automatically to kickback via an inertia-triggered mechanism.



Prior to operating the unit, please read the owner's manual carefully, and most importantly, observe all safety rules.



Observe the maintenance guidelines closely to ensure the long service life of your equipment.

Your dealer will be glad to assist you with any questions.

### Packaging and disposal

Please keep the original packaging in order to protect the equipment against transport damage in case you ever need to ship it or transport it. If the packaging materials are no longer required then they must be disposed of properly in accordance with applicable local regulations. Cardboard packaging materials are raw materials which can be recycled or reused.

At the end of the equipment's service life, please make sure that you dispose of it properly, in accordance with the official directives and regulations that apply in your area.

---

In the best interest of continued technological progress we reserve the right to change the design and configuration of any product without prior notice.

For that reason, no claims can be accepted with reference to text and illustrations in this manual.

	Page
<b>1. Information about these operating instructions</b> .....	<b>4</b>
1.1 <i>Notational conventions used in the operating instructions</i>	4
1.2 <i>Copyright</i>	5
<b>2. Safety regulations</b> .....	<b>6</b>
2.1 <i>Correct use</i>	6
2.2 <i>General safety instructions</i>	6
2.3 <i>Prescribed work clothing</i>	7
2.4 <i>Fuelling</i>	8
2.5 <i>When transporting the equipment</i>	8
2.6 <i>During assembly, cleaning, maintenance and repair</i>	9
2.7 <i>Before starting the tool</i>	9
2.8 <i>Starting the tool</i>	10
2.9 <i>When working with the saw</i>	10
<b>3. Your SOLO chainsaw</b> .....	<b>12</b>
3.1 <i>Standard delivery</i>	12
3.2 <i>Designation of important controls and functional parts</i>	12
3.3 <i>Symbols on the equipment and on the type plate</i>	14
3.4 <i>Components and functional parts under the cowl</i>	14
3.5 <i>Throttle control lock and throttle control</i>	16
3.6 <i>Chain lubrication adjusting screw</i>	16
3.7 <i>Grip heating (models 651H / 656H only)</i>	16
3.8 <i>Functional parts for starting up the chainsaw</i>	17
3.9 <i>Chain brake</i>	18
3.10 <i>Specification</i>	19
<b>4. Preparing the equipment for use</b> .....	<b>20</b>
4.1 <i>Assembly of the guide bar and chain</i>	20
4.2 <i>Adjusting the chain tension</i>	21
4.3 <i>Refuelling and adding oil to the chain lubrication system</i>	22
<b>5. Starting / Stopping the engine</b> .....	<b>24</b>
5.1 <i>Starting positions</i>	24
5.2 <i>Starting settings and start-up</i>	24
5.3 <i>Engine will not start</i>	25
5.4 <i>Switching the engine off</i>	26
<b>6. Hazards caused by kickback</b> .....	<b>26</b>
<b>7. Using the chainsaw</b> .....	<b>28</b>
7.1 <i>Cutting to length</i>	29
7.2 <i>Cutting branches which are under tension</i>	29
7.3 <i>Removing branches</i>	30
7.4 <i>Felling</i>	30
<b>8. Operating and maintenance information</b> .....	<b>32</b>
8.1 <i>Maintenance and care of the cutting gear</i>	32
8.2 <i>Carburettor settings</i>	35
8.3 <i>Maintenance of the air filter</i>	36
8.4 <i>Maintenance of the chain brake</i>	37
8.5 <i>Vibration damping</i>	37
8.6 <i>Spark plug information</i>	37
8.7 <i>Replacing the fuel filter</i>	37
8.8 <i>Scheduled maintenance</i>	38
8.9 <i>Self-help tips</i>	39
8.10 <i>Shutdown and storage</i>	39
<b>9. Permissible cutting gear and further accessories</b> .....	<b>40</b>
<b>10. Parts subject to wear and tear</b> .....	<b>44</b>
<b>11. Guarantee</b> .....	<b>44</b>
<b>12. CE Declaration of conformity</b> .....	<b>45</b>
<b>13. For USA only: ECW Statement / Manufacturers Warranty Coverage</b> .....	<b>45</b>

## 1. Information about these operating instructions

These **operating instructions** are an integral **part of the equipment**.

 They contain important information and instructions for handling the equipment. Always follow any specified **safety regulations** and **instructions**, as they are a prerequisite for ensuring that you **work safely** with the equipment.

 These **operating instructions** must be kept available at the **place of use** of the equipment at all times, and they must be read carefully by everybody who works on or with the equipment (including for maintenance, care and repairs).

### 1.1 Notational conventions used in the operating instructions

Symbols for warnings and instructions used in the operating instructions:



**Danger!** Failure to comply with the instructions could cause accidents with potentially **life-threatening injuries**.



**Caution!** Failure to comply with the instructions could result in **damage to the equipment** or other material damage.



**Carefully read the operating instructions.** This applies before taking the equipment into operation for the first time and before any maintenance, assembly or cleaning work.



Always wear the prescribed **clothing**. Refer also to the notes in Chapter 2.3, "Prescribed work clothing".



Always wear **sturdy shoes** with good grip, preferably special safety shoes.



Wear **safety gloves**. This applies to **all work with, or on, the equipment**.



Before starting the engine, put on **ear defenders** and a **visor**.



**Switch off the engine** - set the stop switch to "Stop".



**Smoking is prohibited** anywhere near the power tool and in the location where it is refuelled.



Keep the power tool and fuel canisters away from **naked flames**.



- The power tool generates **exhaust gases**;  
and  
- **petrol vapours** are **toxic**;  
→ Do not start the engine or refuel the tool in enclosed rooms.



**Activating the chain brake:** Press the hand protection forwards towards the guide rail (see Chapter 3.9, "Chain brake")



**Release** the chain brake and pull the hand protection back towards the front handle see Chapter 3.9, "Chain brake").



**Caution: Kickback**  
It is very important that you read the warnings in Chapter 6, "Hazards caused by kickback".

Important: If a **symbol** is presented in the **middle of the page** directly underneath a chapter heading then the note or warning applies to the **entire chapter**.

In addition, the following pictograms are used in these operating instructions to represent the relevant functional parts of the equipment:



**Grip heating switch**  
Models 651H / 656H only



**Chain lubrication:** Symbol above the tank cap for chain lubrication.



**Fuel mixture:** Symbol above the fuel mixture tank cap



**Winter operation:** At ambient temperatures below 5°C set the sliding switch behind the main air filter to this symbol.



**Normal operation:** At ambient temperatures of 5°C or higher set the sliding switch behind the main air filter to this symbol.

### Emphasised text

- **Underlined text**
  - For **headings** which relate directly to the next paragraph.  
In order to present information more clearly, **individual paragraphs** with headings are **framed in boxes**.
- Text in **italics**
  - For **hints** and notes which help the user to use the equipment more easily.

### Structure

The operating instructions are divided into **main chapters** and **sub-chapters**. The table of contents on page 3 shows a detailed overview of how this document is structured.

### Headers

The relevant chapter heading is printed in the header on each page to help readers quickly find what they are looking for.

### Pictures and diagrams

Some of the pictures and diagrams used in these operating instructions are schematic illustrations which do not necessarily show exactly your model. However, the content must always be observed.

## 1.2 Copyright

The operating instructions are protected by copyright and commercial property rights. Any misuse of the contents (texts and illustrations) without written authorisation from the manufacturer is prohibited, and offenders may be liable to prosecution.

## 2. Safety regulations

### 2.1 Correct use



The chainsaw must only be used to cut wood or wooden objects. It must only be used in the working situations described in Chapter 7, "Using the chainsaw".

Loose cutting objects must be safely secured (e.g. on a sawhorse). When cutting down overgrown trees and branches, please refer to the notes on cutting down trees and removing branches in Chapter 7, "Using the chainsaw".

The chainsaw must not be used for any other purpose, for example to cut plastics or metals.

### 2.2 General safety instructions

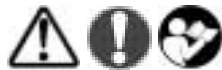

Before you start using the saw for the first time, please take the time to carefully **read** through **these operating instructions**, and make sure you keep them in a safe place. At all times the instructions must be kept available at the place where the saw is being used. The instructions must be read by anybody who works with or on the device (including for maintenance, care and repairs).

Take special care when using this power tool. By handling the power tool recklessly or without the necessary care and attention you can put yourself in **grave danger**. These are based:

- Firstly on the characteristics of the power tool, such as:
  - The high speed of the saw chain, the sharpness of the cutting teeth and the magnitude of the forces and torques that can be developed by the power tool,
- and secondly on the hazards arising from the object being cut when work progresses very quickly,
  - particularly when working in a forest or on cutting objects which are under stress.

Always work with the utmost care and constantly remind yourself of the potential dangers and hazards that could occur. Never undertake any work you are not fully comfortable with or if you are not in a position to fully assess the risks involved. If you are still unsure after reading these operating instructions, please consult a specialist or enrol in a training course for safe handling and use of the power tool (e.g. at a specialist forestry training centre).

If you ignore these safety instructions you could be putting your life at risk. Please also make sure that you comply with all of the health and safety requirements of the professional trade associations.

- When operating in highly flammable vegetation and in areas affected by drought, keep a fire extinguisher handy (risk of fire).
- You should request and receive instructions from the vendor on the safe operation if you are using this type of product for the first time.
- Children and young people under 18 years may not work with this power tool, with the exception of young people over 16 years of age who are being trained under supervision.
- The power tool can be operated easily - even on start-up - by one person. Keep bystanders and animals away from the working area. When working near thickets, be aware that children and animals may be hidden there. Immediately stop the machine and the cutter if any person or animal comes close to the working area. The operator is responsible for any accidents or damage caused to parties or property.
- This machine may only be passed on or lent to third parties if they are familiar with the safe use of this product and with these instructions. Always supply the manual with the machine.
- Ensure you are rested and in good health when using this machine.
- Persons under the influence of alcohol or drugs, including prescription drugs, are not allowed to use this machine, as their ability to quickly react to potential danger may be impaired.
- Never alter, change or modify any safety equipment or functional assemblies on this machine.

- Only use this machine if it is in good, safe condition. Always check the machine prior to use. **Risk of accident!**
- Only use those accessories and attachments that have been supplied by the manufacturer and that are expressly approved for attachment.
- The reliability and safe operation of your machine depend on the quality of parts used with the machine. Only use original spare parts. Original spare parts are identical with genuine production parts and guarantee best quality in material, dimensions, function and safety. Original parts and accessories are available from your specialist dealer. Your dealer has been supplied with appropriate documentation to determine the correct parts. Your dealer is frequently supplied with updates about improvements to the equipment. Please note that the use of non-original parts will void your warranty.
- Always store the machine in a safe place and in such a way that it will not pose any danger. Stop the engine when the machine is not used.

Persons who disregard safety instructions, operating or maintenance instructions may be liable for any damage or consequential losses.

### 2.3 Prescribed work clothing



In order to prevent injuries, please make sure that you wear the prescribed clothing (trousers with a cut protection inlay are strongly recommended) and use all the required personal protection equipment. This clothing should be practically oriented to the application (for example a tight fitting work suit), but should not be confining.

*We recommend:*

- SOLO forest and countryside work jacket EN 340 Part no: 99 303 000 + size (2[s] - 6[xxl])
- SOLO Outdoor Knee-breeches Part no: 99 020 95 + size (024 - 106)
- or SOLO Outdoor dungarees Part no: 99 020 94 + size (024 - 106)

Never wear scarves, ties, jewellery or other items of clothing, which might get caught in the equipment, in brush or on branches. Safely tie back long hair (use a cap, helmet or similar).



Wear sturdy shoes with a good tread - ideally safety shoes.

*We recommend: SOLO leather forest boots Part no: 99 305 10 + size (36 - 48)*



Wear protective gloves with non-slip palms.

*We recommend: SOLO Forst Part no: 99 390 13 + size (09 / 10 / 12)*



Use personal hearing protection and a face protector (e.g. a visor on a safety helmet). Always wear a safety helmet when working in woods or forests. Falling branches pose a serious risk.

*We recommend the SOLO safety helmet with face and hearing protection, order no.: 99 390 1101 (one size)*

## 2.4 Fuelling



Petrol is very light and highly flammable. Keep away from open flames and never spill fuel. Do not smoke at the operating site or at and near the refuelling site!

- Stop the engine prior to refuelling.
- Let the engine cool down before refuelling - fire risk!
- Open the tank lid slowly to allow any excess pressure in the tank to be reduced without the risk of petrol spraying out.
- Fuel may contain substances similar to solvents. Prevent products made from mineral oil coming into contact with skin and eyes. Wear protective gloves during filling with fuel. Frequently change and clean protective clothing.
- Avoid breathing in fuel vapour.
- The refuelling site should be well ventilated.
- Avoid any soil spillage of fuel or oil (protection of the environment). Use a suitable mat.
- Immediately clean any spilled fuel on the machine. Change contaminated clothing without delay.
- Always tighten the fuel tank cap firmly by hand without using any tools. The fuel tank cap must not be able to work itself loose as a result of the vibrations of the engine.
- Check for petrol leaks. Do not start the machine or work with the machine if there is a petrol leak. Life threatening risk from burns!
- Store fuel and oil in approved and correctly labelled containers.

## 2.5 When transporting the equipment



- When carrying the chainsaw for short distances (from one working area to the next), always apply the chain brake so that the chainsaw is blocked (preferably switch the engine off as well). Carry the chainsaw by the front handle. The guide rail of the chainsaw should point backwards. Avoid touching the muffler (risk of being burned).
- Never carry or transport the power tool while the cutting tool is running.
-  When transporting the equipment over longer distances, transporting it in vehicles or shipping it, always **switch the engine off** and attach the chain guard.
- To prevent leakage of fuel or oil and damage in general, make sure that the device is secured so that it cannot fall over when it is transported in vehicles. Check the fuel and chain lubrication tanks for leaks. Ideally you should drain the tanks prior to transport.
- Always empty the tanks before dispatching the unit.

*Recommendation: Please keep the original packaging in order to protect the equipment against transport damage in case you ever need to ship it or transport it.*



## 2.6 During assembly, cleaning, maintenance and repair



- The power tool must not be assembled, maintained, repaired or stored in the vicinity of naked flames.
- The engine must be switched off and the stop switch set to "Stop" for the duration of all work performed on the guide bar and saw chain (for assembly, cleaning, maintenance and repairs) (ideally the spark plug connector should be unplugged as well). Always use protective gloves.
- The power tool requires regular maintenance. Only perform maintenance or repairs yourself if the relevant operations are covered in the operating instructions. All other work should be performed by an authorised specialist workshop.
- During maintenance of the silencer or when checking that the silencer is firmly positioned, never touch the silencer if it is still hot – risk of burns! The silencer gives off extremely large amounts of heat.
- Only genuine replacement parts supplied by the manufacturer must be used for any repairs.
- No changes must be made to the power tool, as this could affect the safety of the device and increase the risk of accident or injury.

## 2.7 Before starting the tool



Check the tool every time before starting it to make sure that the complete power tool is operationally safe. The following points should be checked **in addition** to the points listed in the operating and maintenance instructions (chapter 8):

- The stop switch must be easy to switch.
- The throttle control must move freely and return automatically to the idle position. If the throttle control is operated while the choke lever is pressed in then this must cancel any part throttle stop that is set.
- The guide bar must be firmly secured. Always check that the chain has the correct tension and adjust the tension if required before starting the tool.
- Also check that the ignition cable and spark plug connector are firmly in place. If there is a loose connection this can result in sparks which could ignite any escaping fuel/air mixture – fire hazard!

If anything is not as it should be, signs of damage are evident, settings are incorrect or the functional integrity of the unit is compromised, do not start up the power tool. Instead, have it checked by a specialist workshop.

## 2.8 Starting the tool



- The power tool must only be started up if it is fully assembled.
- When starting the tool, keep a minimum distance of 3 metres to where the tool was refuelled. Never start the device in an enclosed room.
- Make sure that you have a secure footing on firm ground when starting the tool. Always check that the ground is level and keep a safe hold of the power tool.



Perform the start-up routine as described in chapter 5. "Starting the engine / stopping the engine".



Once the unit has been started, check the idle setting. The cutting blade must be stationary during idling.



Once it has warmed up, switch the engine off and recheck the chain tension and adjust as required.

## 2.9 When working with the saw



The following safety rules must also be followed in addition to those already listed:

- Check the operation of the chain brake every time before you start work (see Chapter 3.9, "Chain brake").
- Work on windfall must only be performed by trained persons.
- As soon as the engine is running, it produces toxic exhaust gases which may be colourless and odourless. Never start up the tool in enclosed spaces. Always make sure that there is sufficient air exchange if you are working under restricted conditions, such as in a dip or a ditch.
- Do not smoke at the place of work or in the close vicinity of the power tool, as this would be an increased fire hazard.
- Work carefully, deliberately and calmly and do not endanger the safety of others.
  - Make sure that visibility and lighting conditions are good.
  - Stay within calling distance of others who could help in the event of an emergency.
  - Take breaks in good time.
  - Be aware of potential sources of danger and take appropriate precautionary measures. Remember that the use of ear defenders makes it more difficult to hear other sounds. This may also mask sounds warning of imminent danger or shouts of warning etc.
  - Remember that freshly debarked wood is very slippery (bark). Also take care in the wet, when the ground is slippery, on slopes on uneven terrain.
  - Look out for obstacles and hazards that could trip you up, e.g. tree roots, tree stumps and edges. Take special care when working on slopes. Never work while standing on unstable ground.
  - Always hold the power tool firmly with both hands and make sure you have a secure footing on stable ground at all times.
  - Never use the saw above shoulder height and avoid leaning too far forward. Never use the saw while standing on a ladder, and never climb the tree holding the saw. The only safe way to reach greater heights is to use a hydraulic lifting cabin.
  - Move the chainsaw in such a way that no part of your body would be in the way if the arc of movement of the saw chain was extended.

- Never touch the ground with the chainsaw while it is running.
- Do not use the saw to prise off or scoop away pieces of wood or other objects.
- Longitudinal cuts should be made at as flat an angle as possible. Special care is required here, as the bumper spikes cannot engage.
- Be careful when cutting wood which has splintered, as sawn off pieces of wood can be torn off and fly off at high speeds (risk of injury).
- Switch the engine off if you notice any significant changes in the behaviour of the power tool.
- Never touch the silencer while it is still hot – risk of burns. Never set down the hot power tool in dried grass or on other flammable objects. The silencer gives off extremely large amounts of heat (fire hazard).
- Never work with a defective silencer or without a silencer. You risk damaging your hearing and burning yourself on the device.

### First Aid

A first aid box should always be available on-site. Immediately replace any materials you have used:  
Note:

Over exposing persons with circulatory problems to vibrations can lead to damage to their nervous system or blood vessels. The following symptoms may occur from vibrations to fingers, hands or the wrists: Numbness, itching, pain, twinges, changes to the colour of the skin or the skin itself. Seek medical advice if you experience any of these symptoms.

### 3. Your SOLO chainsaw

#### 3.1 Standard delivery

- **Chainsaw – basic unit** (without guide bar and saw chain)
- Depending on the selected version, possibly the **guide rail, saw chain, chain guard**
- Models 644, 651SP, 651, 651H and 656SP: **sprocket 0.325” – 7**, preassembled
- Models 656 and 656H: **sprocket 0.325” - 7** and **sprocket 3/8” – 7**, not preassembled
- **Tool:** Combination tool (spark plug spanner with screwdriver), plus additional screwdriver
- These **Operating Instructions**

#### 3.2 Designation of important controls and functional parts

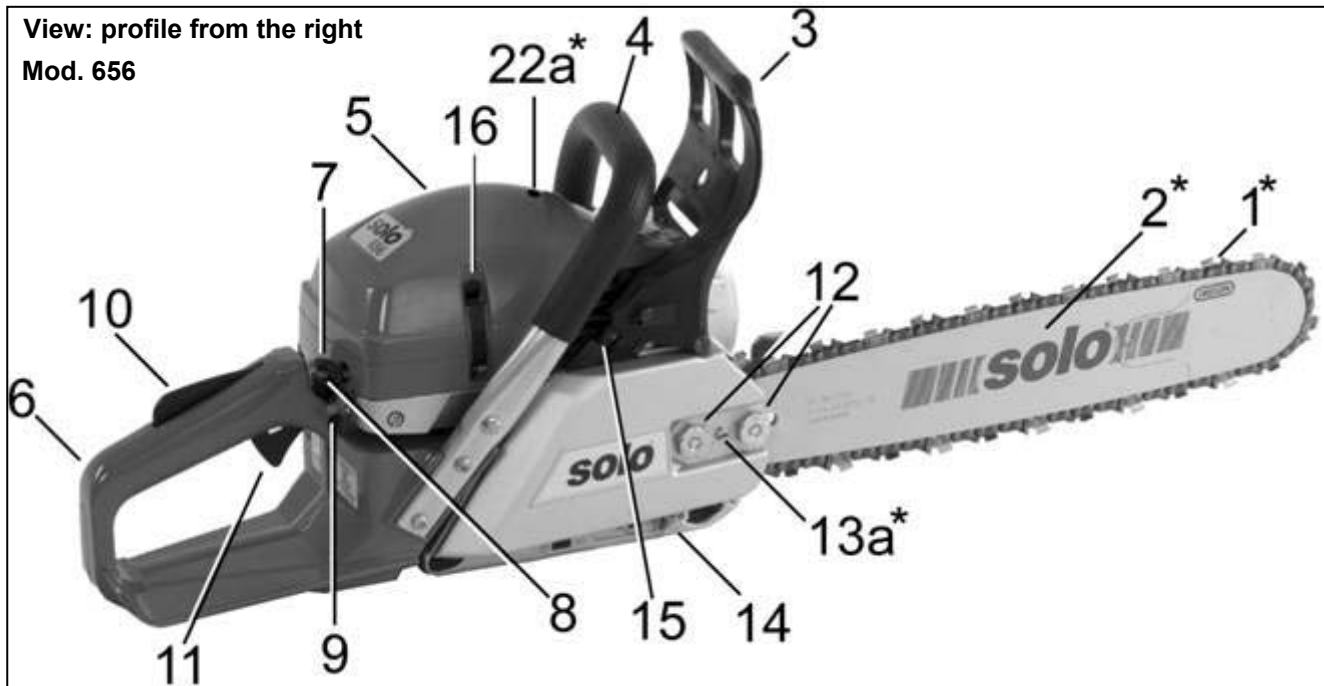

1*. Saw chain	15. Chain brake release spring
2*. Guide bar	16. Cowl fastening clips
3. Hand protection	17. Starter handle
4. Front handle	18. Stop switch
5. Cowl	19. Fuel tank cap
6. Rear handle	20. Chain lubrication oil tank cap
7. Choke	21. Primer
8. Part throttle control pin	<b>Not always standard, depending on the version</b> 22a*. Decompression valve on top 22b*. Decompression valve on the side
9*. Grip heating switch (models 651H / 656H only)	23. Side cover Pre-filter area - Printed: "PRE-FILTER"
10. Throttle control lock	24. Idling stop screw <b>T</b>
11. Throttle control	25. Carburettor adjusting screws ( <b>H / L</b> ) (for use by a specialist workshop only)
12. Retaining nuts for the rail cover	26. Bumper spikes
13a*. Chain tensioning bolt on the side 13b*. Chain tensioning bolt in front	27. Exhaust
14*. Chain guard plate	28. Adjusting screw, chain lubrication oil quantity

\* depending on the version

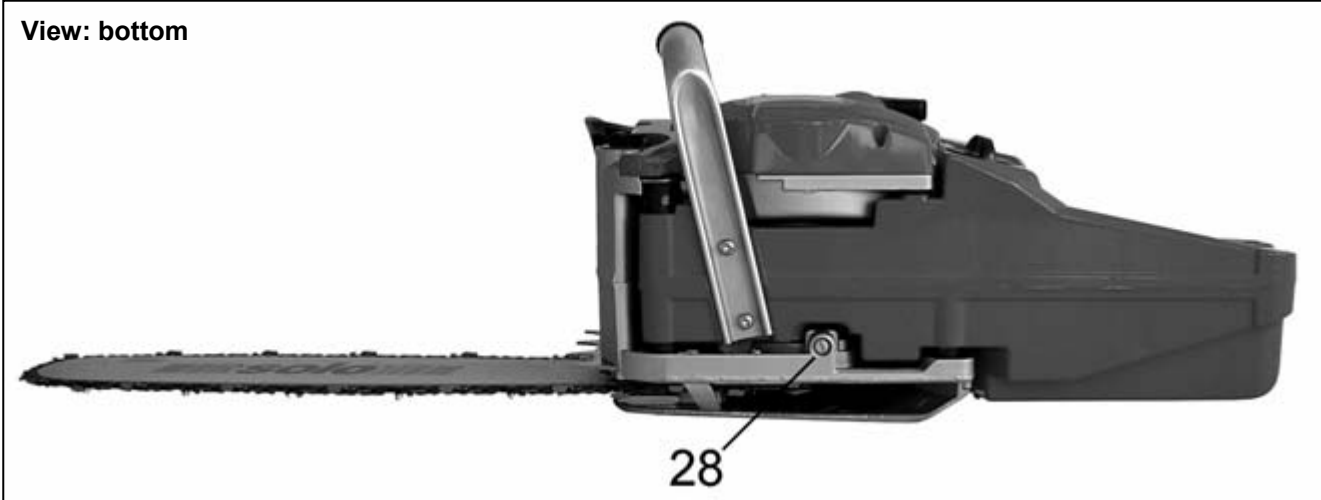
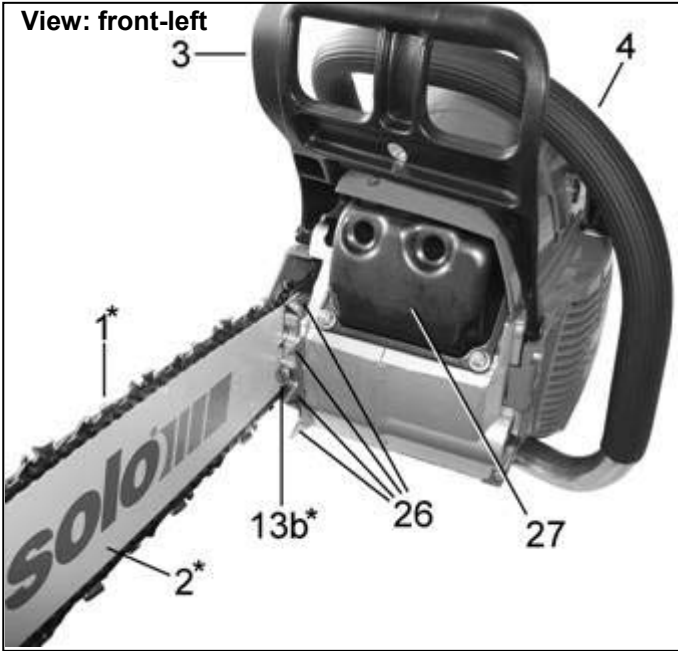
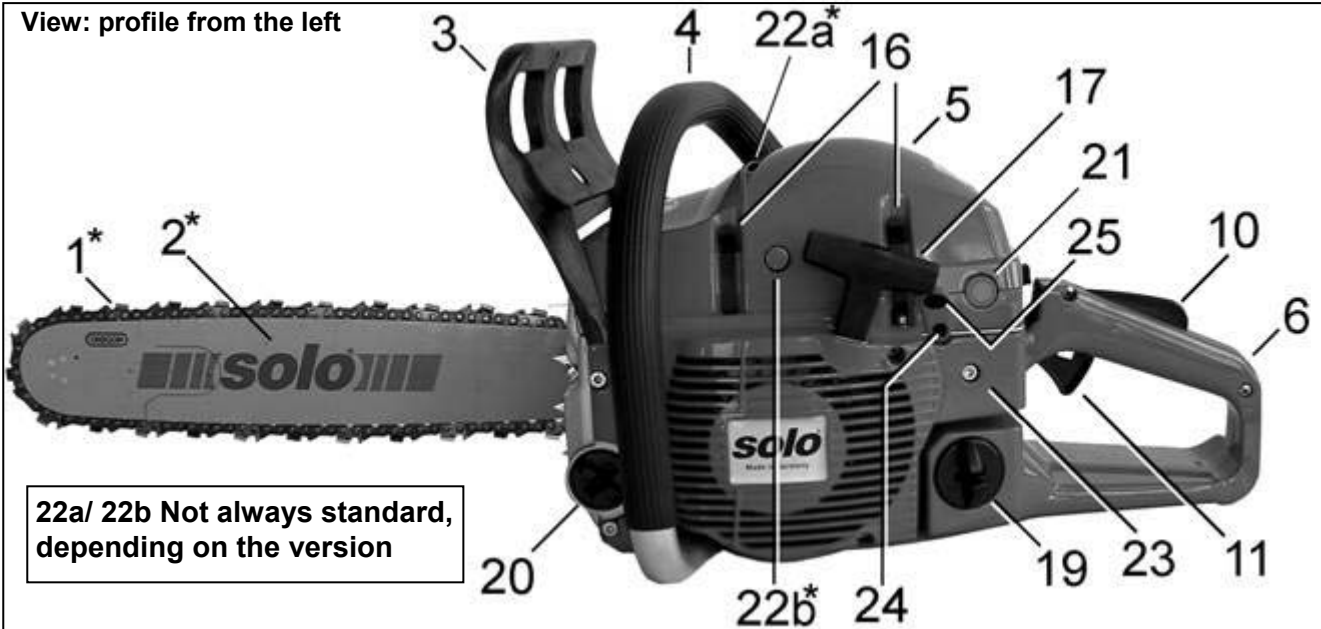

### 3.3 Symbols on the equipment and on the type plate

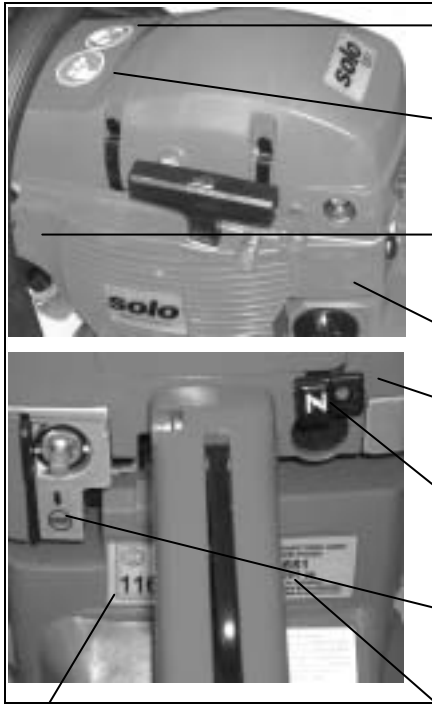

Before starting the engine, make sure that you are wearing a helmet, ear defenders and face protection



Thoroughly read these operating instructions before undertaking any maintenance, installation and cleaning steps



Chain lubrication: symbol above the chain lubrication tank cap



Fuel mixture: symbol above the fuel mixture tank cap



Grip heating ON / OFF switch  
Models 651H / 656H only



**Choke flap:**  
Cold start position → pull the lever out  
Operation and warm start → press the lever in



To stop the engine, move the stop switch (18) down towards this symbol

**LWA - statement**

→ Guaranteed sound power level

Type plate:

**Serial number**



**Type designation**

**Build year (06 → 2006).**

### 3.4 Components and functional parts under the cowl



Taking off the cowl:

- Release the three fastening clips (16), preferably by applying a screwdriver in a twisting motion.
- Lift off the cowl (5) upwards.

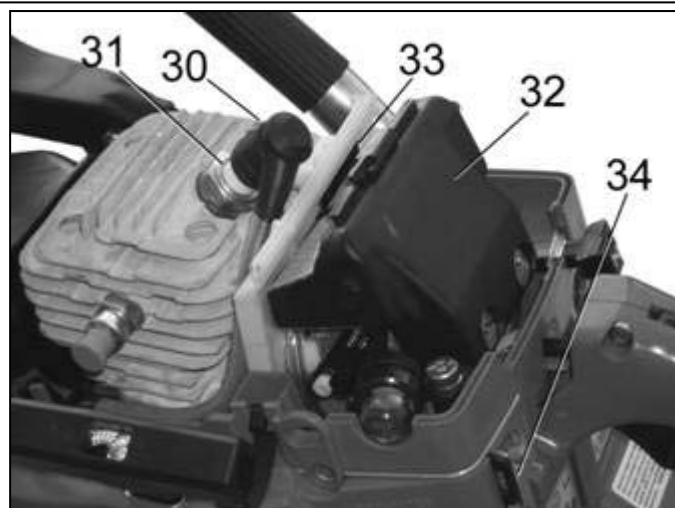

Components under the cowl:

- 30. **Spark plug connector**
- 31. **Spark plug**
- 32. **Main air filter**
- 33. **Sliding switch for winter and normal mode**
- ( 34. **Pre-filter**)

Settings for winter operation / standard operation

In order to prevent icing on the carburettor at low outside temperatures (below 5°C), the intake air can be preheated by setting the slide valve (33) to winter mode.

The slide valve is directly accessible once the cowl (5) has been taken off with the aid of a screwdriver.

**Winter operation:**

At ambient temperatures below 5°C set the sliding switch (33) to this symbol on the left.

**Standard operation:**

At ambient temperatures of 5°C or higher it is very important to slide the sliding switch (33) back to this symbol.

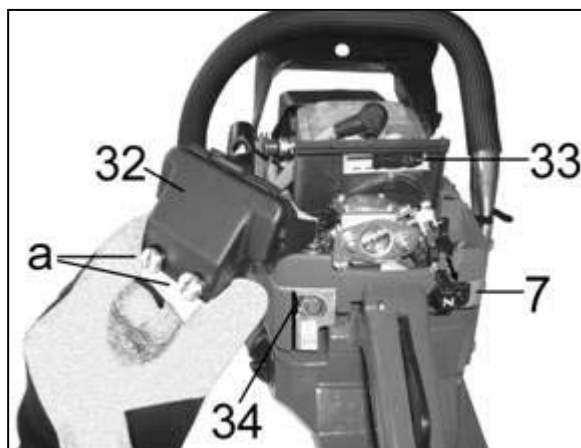

Failure to do so can lead to engine damage as a result of overheating.

Taking off the main air filter

Always pull out the choke lever (7) before removing the main air filter (32) to prevent any dirt from getting into the intake opening of the carburettor.

The main air filter (32) can be taken off (e.g. for cleaning) by undoing the two retaining screws (a).

When installing the main air filter again, make sure it makes clean contact with the carburettor.

**33. Sliding switch for winter operation / standard operation**

*(The mechanism is very clear to see in this disassembled state.)*

(34. **Pre-filter**) .

Fitting the cowl

For ease of installation press the hand protection (3) forwards (chain brake is applied).

- Fit the cowl, making sure it goes on straight.
- Insert the cowl in the slot on the main housing, making sure that it fits properly in the slot all the way around.
- Once the cowl is correctly seated, secure the cowl again using the three fastening clips (16).

### 3.5 Throttle control lock and throttle control



To release the throttle control (11):

- Hold the rear handle with your right hand - the throttle control lock (10) is activated by the flat of your hand  
→ The throttle control is released.

### 3.6 Chain lubrication adjusting screw

 Your new SOLO chainsaw is equipped with an automatic chain lubrication system which automatically stops the delivery of oil when the chainsaw is idling (Eco-Matic). When the throttle is operated and the saw chain is driven again the chain lubrication automatically restarts.

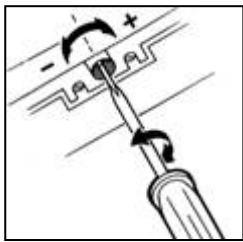

To adjust the amount of oil delivered by this system during operation, the control screw (28) on the underside of the chainsaw can be adjusted approximately two turns from plus(+) to minus(-).



As a guideline, we recommend that if you are using 38cm cutting gear to cut wood which is still moist then the mid-position between (+) and (-) is a good starting point. Adjust the controls to deliver slightly more oil if you are cutting dry wood.

### 3.7 Grip heating (models 651H / 656H only)



On the 651H and 656H models, the electric grip heating can be switched on via the switch (9) (move the switch to the top position ↑).

Heat builds up slowly both via the front handle for the left hand and via the rear handle for the right hand - in similar fashion to the rear window heating system on a car.

Particularly in applications in a damp environment, under cold temperatures or high humidity the grip heating helps to prevent working gloves from becoming excessively soaked and stimulates circulation to the hands.



3.8 Functional parts for starting up the chainsaw

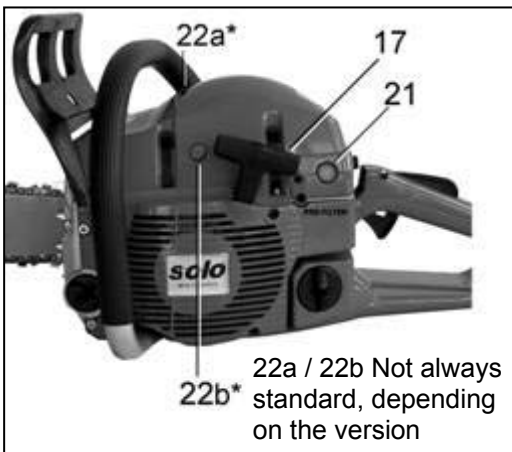

Primer (21)

On delivery, after extended periods in which the chain saw has not been used and if the tank has been run completely dry there will be no fuel mixture in the carburettor immediately after refuelling.

In order to make it easier to start the chainsaw under these circumstances, press the primer repeatedly (at least 5x) to pump fuel mixture into the carburettor.

Any excess fuel mixture pumped into the carburettor is automatically flushed back into the tank.

**Not always standard, depending on the version: Decompression valve (22a / 22b)**

When the decompression valve is depressed, the compression pressure in the combustion chamber is reduced. This means that the engine offers less resistance during start-up, which makes it noticeably easier to start the engine. When the cable is pulled the decompression valve automatically jumps back to the normal position. If you need to pull the starter cable more than once to start the engine (e.g. during a cold start), press the decompression valve again each time.

Starter handle (17) and starter cable



The following instructions are intended to extend the service life of the starter mechanism:

- To start the engine, first pull the starter handle carefully until a first resistance is felt (top dead centre point of the piston), and then pull it through in a fast and strong motion.
- Always pull the cable in a straight direction.
- Do not allow the cable to chafe on the edge of the cable eyelet.
- Avoid pulling the cable all the way out - risk of breaking the cable.
- Always guide the starter handle back to its starting position - do not just let go and allow it to speed back by itself.

A damaged starter cable can be replaced by a specialist.

Choke lever (7) and part throttle control pin (8) → part throttle setting

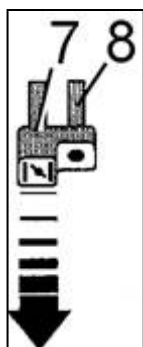

The choke lever is pulled out (7) to close the starter flap on the carburettor (cold start setting).

This also activates the part throttle setting at the same time, which can be seen from the pulled-out part throttle control pin (8)

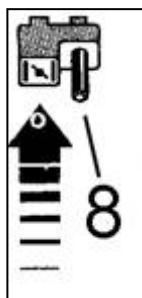

When the choke lever is pushed back in (the starter flap on the carburettor is open) the part throttle setting remains active – this can be seen from the part throttle control pin (8), which is still pulled out.

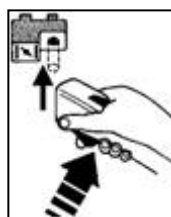

Operate the throttle control to cancel the part throttle setting.  
→ The part throttle control pin (8) jumps back into place.

This applies both when the engine is running and when it is switched off.

### 3.9 Chain brake

When the chain brake is activated, it stops the saw chain in a fraction of a second.

#### Automatic engagement:

In an emergency, the chain brake engages instantly in response to the inertia caused by kickback.

 Please note that even the highly effective automatic chain brake cannot offer complete protection against injury. Always work with great care and always avoid working situations which would put you at risk of kickback

#### Manual activation:

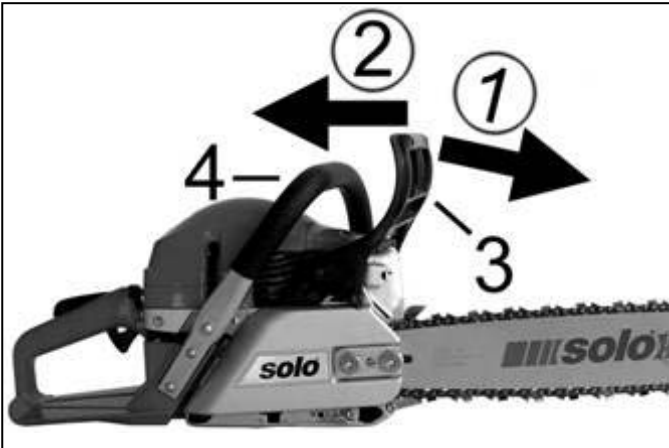

 ① To manually activate the chain brake, press the hand protection (3) forwards towards the guide bar.

 ② To release the chain drive (i.e. cancel the chain brake), pull the hand protection (3) back to the front handle (4) again.

Manual activation of the saw chain brake is intended as a means of immobilising the tool under the following circumstances:

- in order to provide a quick response in an emergency,
- in all situations in which the operator cannot knowingly control the position of the guide rail or in which the risk of unintentional contact between the saw chain and a foreign body or the user himself cannot be entirely excluded. This applies particularly when
  - starting the engine,
  - carrying the power tool,
    - e.g. when assessing the object being cut or the surroundings
    - as well as when walking from one working area to the next.

 In order to avoid excessive wear, the chain brake should not be applied until the chainsaw has come to a standstill - except of course in an emergency. During start-up, once the engine has started the part throttle setting should be cancelled as soon as possible by briefly pulling the throttle control. This ensures that the engine does not have to work against the blocked chain for too long under part throttle.

#### Each time, before commencing your work, check the function of the chain brake as follows:

- Start the engine (see chapter 5.)
  - trigger the chain brake at idle speed
  - briefly operate the throttle once with the chain brake activated
- the chain should then not move.

 Never operate the chainsaw if it is faulty; instead let a service workshop check your power tool immediately.

## 3.10 Specification

Chain saw		644	651SP	651 / 651H	656SP	656 / 656H
Engine type		SOLO single cylinder two-stroke engine				
Engine capacity	cm <sup>3</sup>	45	51		56	
Bore / stroke	mm	42 / 32,6	45 / 32		47 / 32	
Max. power at rpm	kW/ rpm	2,6 / 10.200	2,7 / 9.400	2,9 / 9.500	2,8 / 9.400	3,2 / 9.500
Max. Drehmoment at rpm	Nm / rpm	2,8 / 6.500	2,9 / 6.000	3,0 / 6.000	3,0 / 6.000	3,3 / 6.000
Max. permissible speed rpm no load with cutter		13.000 ± 200	12.500 ± 200	13.500 ± 200	12.500 ± 200	13.500 ± 200
Medium idling speed	rpm	2.700± 200				
Clutch engagement speed	rpm	4.200± 200				
Fuel tank capacity	l	0,6				
Fuel mix ratio:		with <b>SOLO 2T engine oil</b> with other two-stroke oils				
		1 : 50 1 : 25				
Fuel consumption at max. power (ISO 7293)	kg/h	1,4	1,5	1,5	1,5	1,6
Specific consumption at max. power (ISO 7293)	g/kWh	541	556	528	541	499
Capacity of the chain lubrication oil tank	l	0,35				
Carburettor		All-position diaphragm carburettor with primer and integrated fuel pump				
Air filter	Pre-filter Main air filter	Fine-mesh strainer filter large volume flow filter				
Ignition		Electronically controlled magneto ignition, maintenance free				
Sprocket teeth		7				
Dimensions Height / Width / Length with cutting gear 38 cm (15")	mm	275 / 245 / 770				
Weight without tank contents, guide bar and chain	kg	5,2	5,2		5,3	
In determining the following values regarding the acceleration of vibrations and sound, the different operating conditions were weighted in accordance with the current standards.						
Sound pressure level L <sub>Peq</sub> (ISO 22868)dB(A)		101	101	101	101	102
Sound power level L <sub>Weq</sub> (ISO 22868) dB(A)		111	112	112	112	112
Weighted effective acceleration a <sub>h<sub>v</sub>,eq</sub> (ISO 22867) Handle r.h. side / handle l.h. side/m/s <sup>2</sup>		7,5 / 4,9	7,6 / 4,4	7,6 / 4,4	7,8 / 4,8	7,8 / 4,8

Build year of the power tool → refer to the type plate on the power tool (Chapter 3.3, "Symbols on the equipment and on the type plate").

Permissible cutting gear and the corresponding cutting lengths – see Chapter 9, "Permissible cutting gear and further accessories" (page 40)

## 4. Preparing the equipment for use

### 4.1 Assembly of the guide bar and chain

ENGLISH

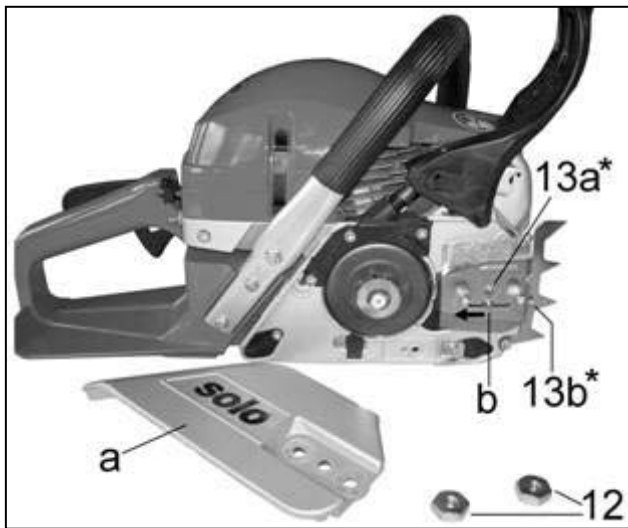

- Undo the retaining nuts on the rail cover (12).
- Take off the rail cover.
- When setting up the tool for the first time, remove the cardboard disc inserted at the factory as transport protection underneath the rail cover before installing the guide bar.
- On used saws, clean the rail contact surface and the oil outlet.
- Use the chain tensioning bolt (13) to move the chain tensioning cam to the left-hand end stop. **Note:** Each time the guide bar is removed and installed, adjust the chain tension cam (b) up to the l.h. end stop.

13a / 13b: depending on the version

On the models 656 and 656H the corresponding sprocket (enclosed with the accessories) for the cutting gear should be installed. Notes on this can be found in the instructions included with the accessories.

**!** Always install matching components (sprocket, guide rail, saw chain) (see Chapter 9, "Permissible cutting gear and further accessories", page 40).

Note for new saw chains:

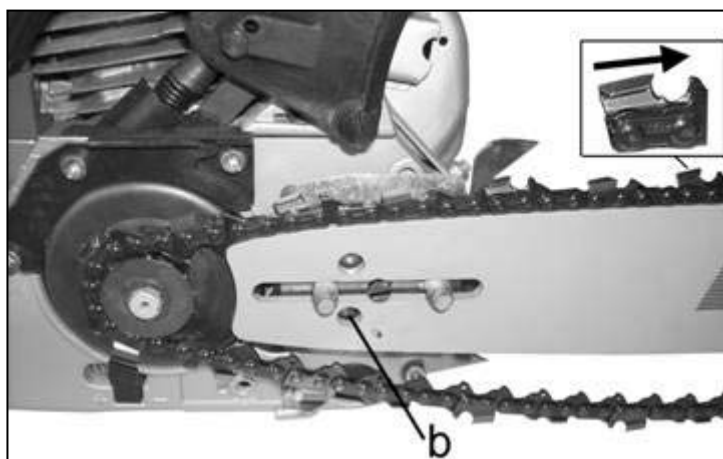

Before installing a new saw chain we recommend soaking it in a container (bowl) with chain oil with anti-fling properties for a certain amount of time (preferably overnight).



- Position the guide bar; in the process, the chain tensioning cam must fully engage in the designated hole in the guide bar.
  - Fit the chain over the sprocket and into the guide groove of the guide bar.
  - The cutting elements of the saw teeth must be on the upper side of the rail facing towards the tip of the rail.
  - Make sure that the drive links engage correctly in the cutouts of the sprocket and in the guide sprocket at the rail tip.
  - Fit the rail cover, but initially only tighten the retaining nuts finger tight.
- After correctly adjusting the chain tension (refer to the next section), tighten the retaining nuts as described below.

## 4.2 Adjusting the chain tension



  The chain has the correct tension if it makes full contact with the guide bar but can still be lifted off the guide bar by hand by around 2 - 4 mm.

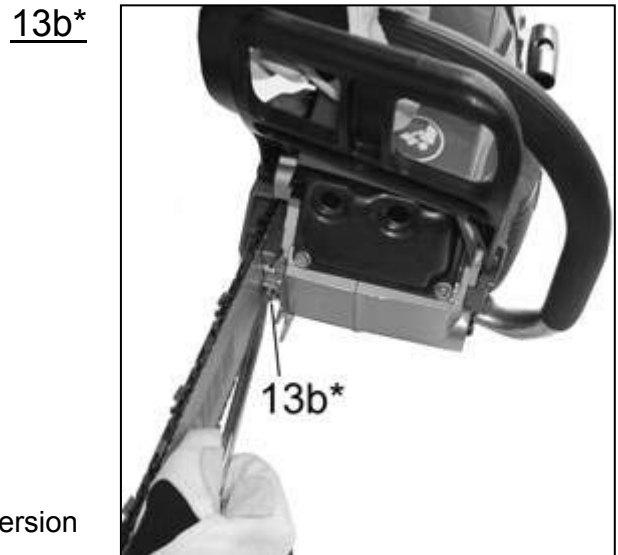
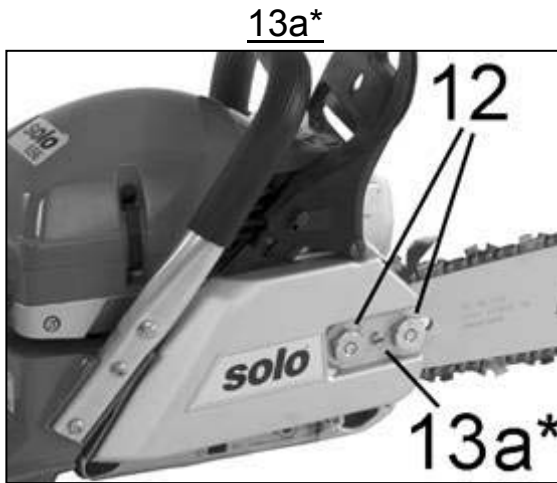

13a / 13b: depending on the version

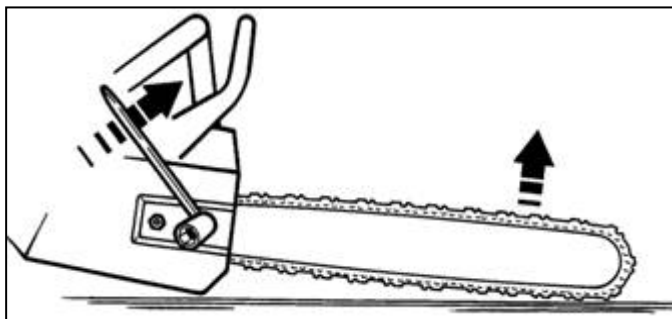

- Loosen the retaining nuts on the rail cover (12) using the enclosed combination tool.
- To increase the chain tension, turn the chain tensioning bolt (13) clockwise,
- To slacken the chain tension, turn the chain tensioning bolt anti-clockwise.





(schematic diagram)

- Place the rail tip on a suitable wooden support (e.g. a tree stump), and in doing so press the guide rail slightly upwards.
- In this position, set the correct chain tension and tighten the retaining nuts.
- Then check the chain tension again and correct as required.

Note: the process of placing the tip down and pushing up the guide rail simulates the working position while cutting.

  Always check the chain tension before starting the device and adjust it as required.

 You should also check the chain tension again and adjust it as required once the power tool has warmed up and again intermittently while working with the tool – but make sure the engine is switched off first!

 As the chain tightens again slightly when the device cools off, slacken the chain tension a little once you have finished work before putting the chainsaw into storage.

### 4.3 Refuelling and adding oil to the chain lubrication system



**!** The tank caps for the fuel tank and the chain lubrication oil tank are sealed by means of an O-ring. Both tank closures should only be tightened finger-tight, without the use of tools.

If the fuel tank cap is stuck you can insert a screwdriver into the slot on the tank cap and use it as a lever **to open the cap**.

#### Fuel information

 A high performance two-stroke engine operated with a petrol:oil mixture (petrol + oil = fuel mixture) or with a special fuel mixture for two-stroke engines available from specialists powers this machine. The fuel mixture can be made up with standard lead-free petrol or with lead-free premium grade petrol. The minimum octane rating for petrol is 92 ROZ.

**!** Unsuitable petrol or deviations in the mixing ratio may lead to serious engine damage!

**!** Avoid direct skin contact with petrol and avoid inhaling petrol fumes - health hazard!



#### Mixing ratio

Petrol in litres	Oil in litres	
	SOLO 2T engine oil 2% (50 : 1)	Other two-stroke oils 4% (25 : 1)
1	0,020	0,040
5	0,100	0,200
10	0,200	0,400

**!** Always use a fuel:oil ratio of 25:1 (4%) for the first five tank fillings. After that we recommend a ratio of 50:1 (2%) with the use of special two-stroke oil "SOLO 2T engine oil" which we can supply. With the use of other brand two-stroke oils we recommend a ratio of 25:1 (4%).

**!** Never store fuel mixture longer than 3 - 4 weeks.

#### Fuelling

  While fuelling always follow all safety instructions and take all safety precautions.

-  • Handle fuel only with the engine turned off.
- Carefully clean the area around the filler inlet.
- Place the machine with the fuel inlet pointing upwards.
- Unscrew the tank lid and fill the fuel mixture up to the lower edge of the filler neck.
- Use a funnel with filter to prevent tank contamination.
- After filling the tank replace the tank lid and tighten firmly.

### Chain lubrication



- Chainsaw oil with an anti-fling additive that helps the oil adhere to the chain should be used for lubrication of the saw chain and guide bar.
- You should generally always add the chain oil whenever topping up with fuel.
- **If the saw is used regularly** we recommend the use of biodegradable chainsaw oil.
-  *The bio-chainsaw oil available from SOLO (order no. 00 83 107, 1 litre) has been awarded the German blue angel symbol for eco friendliness (RAL UZ 48).*
- Biodegradable chainsaw oil only has a limited lifespan and should be used within a period of 2 years from the printed date of manufacture.

 **Important:** If you are planning to not use the saw for more than 2 months and are using bio-chainsaw oil then you will need to drain the oil tank and then add a small quantity of engine oil (SAE 30). Then run the chainsaw for a while to ensure that all bio-oil residue has been flushed out from the tank, oil pickup hose and cutting device. Fill up with bio-chainsaw oil again when you are ready to take the saw back into operation again.

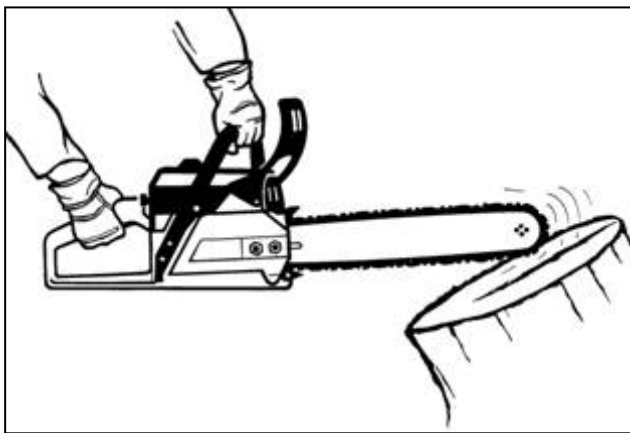

To check the chain lubrication, hold the guide bar above a lightly coloured object (e.g. a tree stump) and allow the chainsaw to run in part throttle mode. A light oil trail should form on the lightly coloured object.

Note: On new saw chains, if the oil tank was completely empty or on delivery of the chainsaw it may take up to a minute until a trace of oil becomes visible. Do not start cutting until you are sure that the chain is being properly lubricated!

(schematic diagram)



**Important:** Never work without chain lubrication. Check the operation of the chain lubrication system and the level of the oil in the oil tank every time before you start work. Never re-use old oil.



Refer to Chapter 3.6, "Chain lubrication adjustment screw", for notes on adjusting the amount of oil delivered by the system.

### Note for new saw chains:

Before installing a new saw chain we recommend soaking it in a container (bowl) with chain oil with anti-fling properties for a certain amount of time (preferably overnight).

## 5. Starting / Stopping the engine



### 5.1 Starting positions

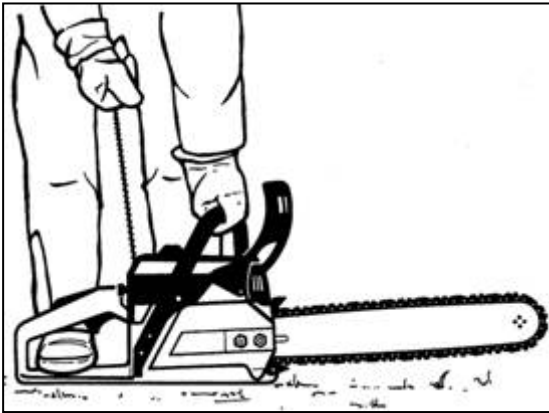

(schematic diagram)

- Take off the chain guard.
  - Place the power tool on level ground which is free of obstructions and make sure that the cutting tool is not touching anything.
  - Place one foot in the rear handle to secure the saw on the ground.
  - Use one hand to firmly hold the saw by the front handle.
  - Use your other hand to pull the starter handle.
-  You must make absolutely sure that there is no risk of contact between the guide bar and any part of your body.

#### Alternative way to hold the saw while starting it up (for experienced users only):

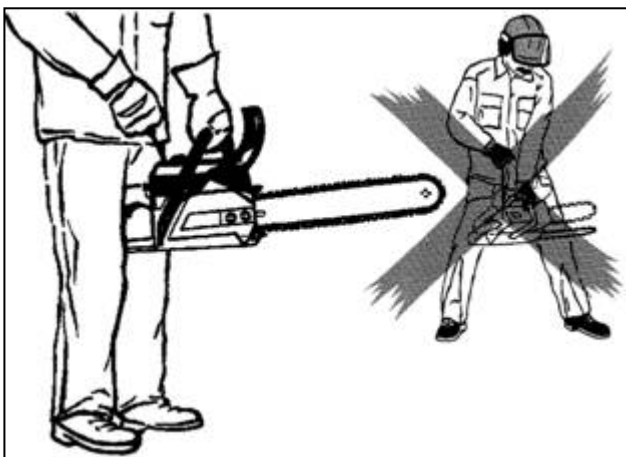



(schematic diagram)

- Take off the chain guard.
  - Firmly grasp the rear handle between your thighs.
  - Use one hand to firmly hold the saw by the front handle.
  - Use your other hand to pull the starter handle.
-  You must make absolutely sure that there is no risk of contact between the guide bar and any part of your body.

- Always start by pulling the starter handle carefully until a first resistance is felt (top dead centre point of the piston), and then pull it through in a fast and strong motion. You must use a confident and firm action to start the engine. If you are unsure about anything, please ask an expert for advice or attend a course on safe handling of the power tool (e.g. at a specialist forestry training centre or similar).

### 5.2 Starting settings and start-up

  Please read the safety instructions before starting up the device.

#### Basic settings (for cold starts and warm starts)

-  Before starting the engine, activate the chain brake to block the chain.
- Depending on the conditions, set the sliding switch (33) either to standard or winter operation (see Chapter 3.4, "Components and functional parts under the cowl")
  - Move the stop switch (18) upwards into its operating position.
  - If necessary, press the primer (21) to pump fuel (see Chapter 3.8, "Functional components for start-up").
  - **Depending on the version:** Before every starting attempt press the decompression valve (22) (see Chapter 3.8, "Functional components for start-up").



[Basic settings (**chain brake, standard or winter operation, stop switch, primer**) as described in the previous paragraph. ]

#### Cold start:



- Pull the choke lever (7) (this also activates the part-throttle setting) [part throttle control pin (8) is pulled along].
- Using the starter handle, start the engine until you hear it briefly ignite.  
Note: the engine cannot start up and continue running while the choke lever is pulled out.



→ After the first audible ignition, immediately:

- Press the choke lever back in again.
- Continue starting until the engine runs
- The engine is then running in part throttle (visible from the part throttle control pin).

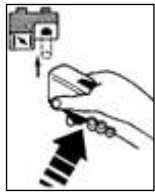

- Briefly operate the throttle control to cancel the part control setting (the part throttle control pin jumps back in again).
- The engine will then continue to run at idle speed.

Note: If the choke lever is not pushed back in when you hear the first audible ignition, the combustion chamber can quickly become saturated if start-up is repeated with the choke lever pulled out. In this case you will be unable to start the device. Please refer to the instructions given in section 5.3, "Engine will not start".

#### Warm start:

Start the engine in idle setting with the choke not pulled out,

or start it in →

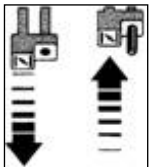

#### part throttle setting:

- by pulling the choke out and pressing it back in again [the part throttle setting is activated as a result, which is visible from the pulled-out part throttle control pin (8)]
- Start the engine until it runs, then briefly operate the throttle control to cancel the part throttle setting (the part throttle control pin jumps back in again).
- The engine then runs on at idle speed.

### 5.3 Engine will not start

If the engine fails to start after several attempts, check whether all adjustments described above have been correctly carried out, particularly that the stop switch is **not** in the "0" position. Try starting once again. The combustion chamber will be flooded, if the engine still fails to start.

In that case we recommend you proceed as follows:



- Remove the cowl. (chapter. 3.4)
- Pull the spark plug cap off the spark plug.
- Remove the spark plug and dry fuel mixture from the electrodes.
- Move the throttle lever up to full throttle. Pull the starter handle several times (with removed spark plug) to clear the combustion chamber.
- Move the throttle lever down to idling position, refit the spark plug, the plug cap and the cowl.
- Repeat the starting process according to the starting settings for a warm start in part throttle setting.

## 5.4 Switching the engine off

Release the throttle control and move the stop switch to the "Stop" position.

 Always make sure that the cutting tool has come to a complete standstill before placing the machine down.

### Tip:

We recommend that users get into the habit of doing the following whenever temporarily switching off the chainsaw. Once the engine has come to a complete standstill,

- move the stop switch straight back to the operating position, and
- activate the chain brake ready for the subsequent start-up.

This will help to make sure that these steps are not forgotten when the chainsaw is next started.

As a general rule, you should always check the starting settings before every start-up.

### Switching the engine off in the event of a malfunction:

If – due to a malfunction of the stop switch – it is not possible to switch the engine off, you can also close the choke flap (choke pulled out) to bring the engine to a standstill..

 Caution – the chainsaw runs at part throttle in the process!

In this case do not restart the tool – have it checked out immediately by a specialist workshop instead!!

## 6. Hazards caused by kickback



When working with the chainsaw, careless or incorrect working methods can cause a dangerous situation which is referred to as "kickback". Kickback forces can occur when the running saw chain comes into contact with solid objects or if the saw chain suddenly gets stuck in the cut. In the process, the chainsaw is accelerated violently and uncontrollably. Depending on the contact point of the running saw chain, the forces acting on the chainsaw are directed as follows, resulting in the corresponding acceleration of the tool:

### 1. Contact point (or sticking point during a cut) at the tip of the guide rail:

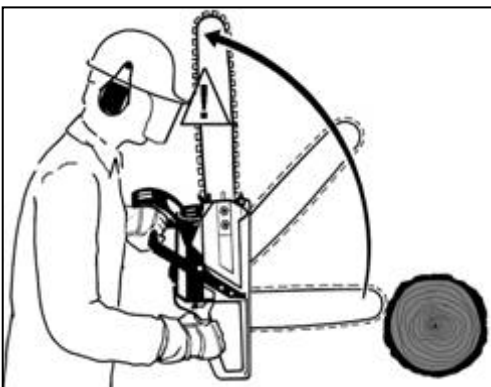

### **Danger:**

- The guide bar is kicked up suddenly and quickly.
- As the user is holding the chainsaw by the handles, this results in a rotational acceleration of the chainsaw, during which the guide bar is accelerated towards the head of the operator.
- Although this rotational acceleration instantly activates the chain brake, the magnitude of the acceleration and the uncontrolled response of the operator can result in serious accidents.

### 2. Contact point (or sticking point during a cut) in the upper area of the guide rail:



#### **Danger:**

- The chainsaw is kicked suddenly in the direction of the operator.
- The magnitude of the acceleration and the uncontrolled response of the operator can result in serious accidents.

Experienced users can perform a so-called "backhand cut". This can only be done by anticipating the sudden acceleration of the tool and supporting the chainsaw in a rearward direction with your thigh before positioning the tool for the cut and while performing the cut.



**Inexperienced users must not use the "backhand cut"!**

### 3. Contact point in the lower area of the guide rail (bumper spikes (a) as the point at which the chainsaw is positioned on the cutting object):

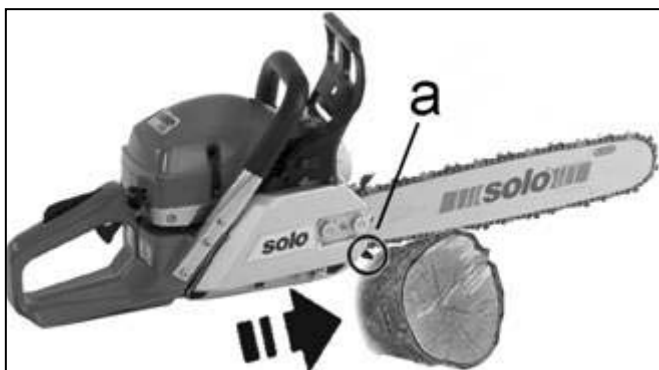

#### **Safe application:**

- The chainsaw is pulled towards the object being sawn.
  - As the bumper spikes on the engine housing are positioned on the object being sawn, the chainsaw cannot be accelerated away.
- The operator is able to control the tool safely.



The following general guidelines should be followed in order to avoid kickback:

- Always hold the chainsaw firmly with both hands. Position your right hand on the rear handle and your left handle on the front handle.
- Before positioning the saw for the cut, apply the throttle and, with the saw chain running, start the cut on the underside of the guide bar as close as possible to the engine housing.
- Never cut more than one branch at a time. When removing branches, bear in mind that other branches may inadvertently come into contact with the saw chain. When cutting to length, look out for other trunks which may be close nearby.
- Special care is required when continuing cuts which have already been started.
- Carefully watch the guide bar during the cut.
- Look out for forces which could compress the cut gap and cause the saw chain to become trapped, particularly on objects which are under tension.
- Always follow the correct procedure for sharpening the saw chain. In the process, pay particular attention to the correct height of the depth limiter.

Professional users can use special working techniques which must only be carried out by experienced users. We recommend that anyone who wishes to safely learn about the more difficult techniques which are not described here should attend a special course (e.g. at specialist forestry training centre).

## 7. Using the chainsaw



 Please make sure that you **follow all safety instructions** and all information in the other chapters of these operating instructions whenever performing any work on or with the chainsaw.

Check list for use (key points only): ..... → 

- Before starting:
  - Power tool in a condition **safe to operate** ..... → Operating instructions (complete)
  - Have the **fuel mixture** and **oil** been topped up? ..... → Chapter 4.3
  - Is the **chain tension** correctly adjusted ..... → Chapter 4.2
- Starting ..... → Complete chapter 5
  - Are the **starting settings** OK.? ..... → Chapter 5.2
    - Has the **chain brake** been activated ..... → Chapter 3.9
    - Sliding switch standard or winter operation ..... → Chapter 3.4
    - **Stop switch** set to operating position..... → Chapter 5.2
    - If necessary, use the **primer** to pump fuel..... → Chapter 3.8
    - Are the **choke** and **part throttle** correctly set? .. → Chapter 3.8 und Chapter 5.2
- While working – **always work in a safe way** ..... → Operating instructions (complete)
  - Check the **chain lubrication**. ..... → Chapter 4.3
  - Check the **chain tension** and adjust as required. .... → Chapter 4.2
  - Check the **idle setting**. ..... → Chapter 8.2
  - Functional test of the **chain brake**. ..... → Chapter 3.9
  - **Assess** the **cutting situation** ..... → Chapter 7 (complete)
  - While cutting, **release the chain brake** ..... → Chapter 3.9
  - **Position the chainsaw for a safe cut**..... → Chapter 6 and chapter 7 (complete)
  - Operating and maintenance information (complete).... → Chapter 8 (complete)
    - Is the **saw chain** sharp? ..... → Chapter 8.1
    - Is the **air filter** clean? ..... → Chapter 8.3
    - etc. .... → Operating instructions (complete)
- After finishing the work:
  - **Slacken the chain tension**. ..... → Chapter 4.2
  - Put the power tool into **safe storage**..... → Chapter 8.10
  - Maintenance, etc. .... → Operating instructions (complete)

 **For cutting**, always make sure that the **chain brake is released**. If the chain brake is activated then you must not activate the throttle control, except in order to perform a functional test of the chain brake, in which case the throttle may be applied briefly (Chapter 3.9).

### 7.1 Cutting to length

- Make sure that you have a secure footing.
- Clean the area which is to be cut of any foreign bodies like sand, stones, nails etc. Foreign bodies can cause dangerous kickback.



- Loose wooden objects must be firmly secured, ideally with a sawhorse.
- The wood must not be held in place with a foot or by another person.
- Round timber must be secured so that they cannot rotate.

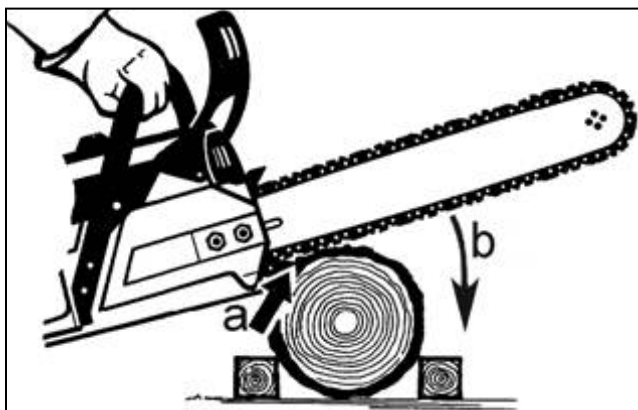

Release the chain brake,

- Apply full throttle and move the chainsaw close to the cutting point,
- position and press the bumper spikes onto the object you wish to saw (a),
- then – and not before – use a pivoting movement (around the point at which the bumper spikes have been positioned) to move the guide bar downwards (b) and start the cut.

(schematic diagram)

### 7.2 Cutting branches which are under tension



The increased tendency for the chainsaw to become trapped means that there is a greater risk of kickback



[See also Chapter 6, "Hazards caused by kickback"]

- First cut around ¼ of the diameter on the compression side (symbol: ⇒ ① ⇐), but be careful as there is a risk of the saw being trapped.
- Then proceed carefully and make a cut at the tension side (symbol: ⇐ ② ⇒).
- On thick trunks which are under a lot of tension offset the cut to one side.

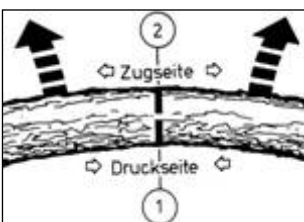

Trunk under tension on the upper side:

**Danger:** The tree will spring back in an upward direction!

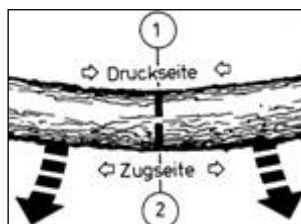

Trunk under tension on the underside:

**Danger:** The tree will spring back in a downward direction!

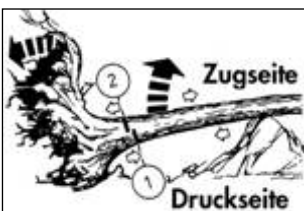

Thick trunks and high tension:

**Danger:** The tree will spring back suddenly and with considerable force. Also watch out for the root clump tipping back.

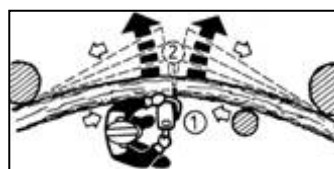

Trunk under lateral tension:

**Danger:** The tree will spring back to one side!

- Always stand on the compression side if the tree is under lateral tension.
- If the saw becomes pinched in the cut, stop the engine and lift the trunk with a bar or other lever, or change its position to open up the cutting gap.

### 7.3 Removing branches

- Do not cut through free-hanging branches from underneath.
- Do not remove branches while standing on the trunk.
- Remove any obstructing branches before you start sawing.
- If you change your standing point, remember that the guide bar must always be on the side of the trunk facing away from your body.
- Always keep an eye on tree and branch movement – plan ahead and proceed with care!
- When removing branches on thick hardwood trees, follow the correct procedure described below to prevent the chainsaw from becoming pinched:

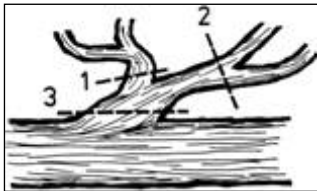

1. Remove any obstructing branches.
2. Cut off any branches which are creating tension.
3. Cut off the main branch (note which side is the compression side and which the tension side).

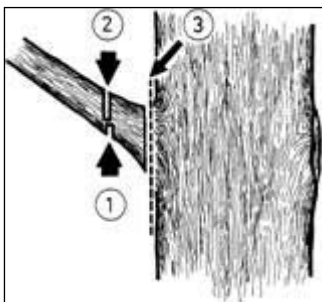

- If it is important that the wood does not tear, make a relieving cut.
- Start this cut on the compression side ①, then finish the cut from the tension side ②.
- The remainder of the branch which is left standing is now no longer under tension and can be cut off close to the trunk ③.

### 7.4 Felling

 Felling trees is dangerous and requires training. If you are a novice then you must not fell any trees. You can attend a training course to learn how to fell trees.

Before felling a tree, make sure that:

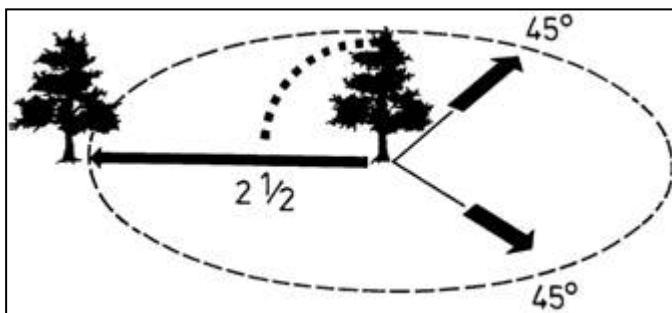

- No persons other than those involved in the felling of the tree are in the felling area.
- Everybody involved in the felling has an unobstructed path of escape. The path of escape should be opposite to the planned direction of the fall of the tree at an angle of around 45°.
- The nearest working area should be at least 2½ tree lengths away

- Before felling a tree you need to carefully check the direction of fall and make sure that no persons, animals or objects are within 2½ tree lengths.

Consider the general condition of the tree:

- Hanging direction – loose or dry branches – height of the tree – natural overhang – is the tree diseased?
- You also need to take into account the wind speed and wind direction. Do not fell a tree under heavy, gusting winds.
- The foot of the trunk must be free of all foreign objects, roots, undergrowth and branches.
- Ensure that you have a secure footing and remove any objects which could cause you to trip.

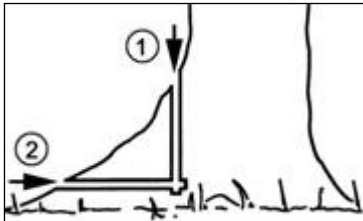
Cutting into the buttress roots:

- Start with the largest buttress root first.
  - Make a vertical cut into the root ①, followed by a horizontal cut ②.
  - Never cut into diseased trunks before felling them.
- ⚠ Leave the buttress root intact as a wedge on the side opposite the direction of fall.

Make the felling notch and perform the felling cut:

The felling notch determines the direction in which the tree falls and helps to control the fall. It is made perpendicular to the fall direction with a cut through  $1/5 - 1/3$  of the trunk diameter. The cut should preferably be made close to the ground.

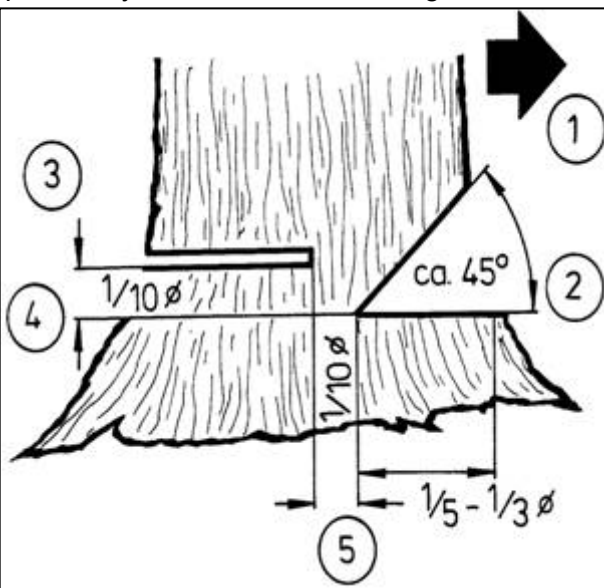

- ① Start with the upper cut (roof of the felling notch).
- ② Then make the lower cut (bottom of the felling notch). The lower cut should meet the upper cut precisely. Check the direction of fall. If the felling notch needs to be corrected, always re-cut it across the full width. In exceptional cases it is also possible to slope the lower cut upwards to obtain a more open felling notch. If the tree is situated on a slope this gives longer control over the fall.
- ③ Call out a warning before positioning the chainsaw for the felling cut. The felling cut is made higher ④ than the bottom of the felling notch ②. This cut must be exactly horizontal. In front of the felling notch around  $1/10$  of the trunk diameter needs to be left as a hinge ⑤.

- ⑤ The hinge must not be cut through, as this could result in loss of control over the fall of the tree.
- Wedges need to be positioned in good time. The felling cut must only be secured with plastic or aluminium wedges, and steel wedges must never be used.
  - During felling, always keep to the side of the tree.
  - When working on a slope, the operator of the saw should stand above or to the side of the trunk or tree being worked on.
  - When the tree falls call out another warning, stand back, observe the crown of the tree and watch out for falling branches.
  - Wait for the crown to swing out.
  - Do not continue work under branches or trees which have become caught.

## 8. Operating and maintenance information



With modern equipment and safety-relevant components, maintenance and repairs must only be carried out by persons with suitable specialist qualifications in a workshop equipped with the necessary special tool and testing equipment. As a result, the manufacturer recommends that all work which is not described in these operating instructions should be performed by a specialist workshop. The experts have access to the training, experience and equipment which is required in order to provide you with the most cost-effective solution. An expert can also offer invaluable advice.



Always follow all of the safety instructions when performing maintenance work!



After the device has been run in for around 5 operating hours, all accessible nuts, bolts and screws (except the carburettor adjusting screws) should be checked for tightness and retightened as required.

It is best to store the device in a dry and safe location with a full fuel tank. There must not be any naked flames or similar nearby. If you plan to not use the chainsaw for a longer period (i.e. more than four weeks), please refer to the information in chapter 8.10 "Shutdown and storage".

### 8.1 Maintenance and care of the cutting gear

#### General information saw chain

Every saw chain is matched to the relevant chainsaw type in terms of its form, cutting performance and design. Only use the genuine SOLO saw chain which is approved for your chainsaw / guide bar type.

The key distinguishing factors for the saw chain are:

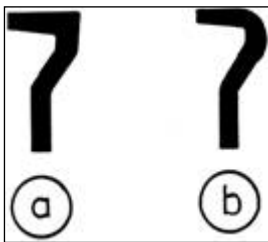

The **form of the cutting elements**:

- a) Solid bit (rectangular cutting tooth, professional chainsaws)
- b) Half bit (half-round cutting tooth, semi-professional / hobby chainsaws)

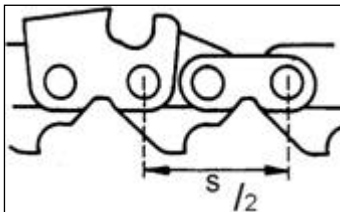

The **pitch**:

This is the distance  $s$  (from one rivet to the next but one) divided by 2. The pitch is quoted in inches.

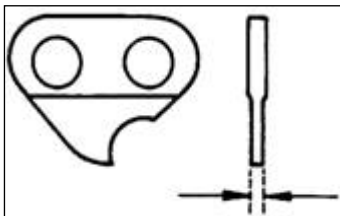

The **driving link thickness**:

This is the thickness of the part of the driving link which protrudes in the guide groove of the rail





### Sharpening the saw chain

Just like any other cutting tool, the saw chain is subject to natural wear. Your chainsaw will only be able to deliver its full potential if the saw chain is correctly sharpened.

Symptoms of a blunt saw chain or one which has been sharpened incorrectly:

- Poor cutting performance and floury chippings → the saw chain is blunt.
- Chip size too small → The depth limiter spacing is too small.
- Chip size too large and increased kickback tendency → The depth limiter spacing is too large.
- Saw pulls to one side while cutting → The saw chain is not evenly sharp.
- Visually apparent damage to the cutting surfaces.

Experience is needed to correctly sharpen the saw chain. If you are unsure, have the saw chain checked by a specialist workshop and re-sharpened as required. The information provided below is intended for experienced users or specialist workshops.

A special round chain file with the correct diameter should be used for sharpening. Normal round files are not suitable.

Chain - code	Pitch in inches	Files Ø mm/inches	Filing angle $\alpha$	Depth limiter spacing $b$ mm/inches
21BP...	.325"	4,8 / $\frac{3}{16}$	30°	0,64 / .025
21LP...	.325"	4,8 / $\frac{3}{16}$	25°	0,64 / .025
73LP...	3/8"	5,5 / $\frac{7}{32}$	25°	0,64 / .025
73D, DP...	3/8"	5,5 / $\frac{7}{32}$	35°	0,64 / .025

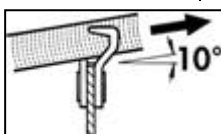

**Filing direction: 10° upw**  
21BP..., 21LP..., 73LP...

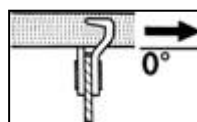

**Filing direction: 0° horizon**  
73D, DP...

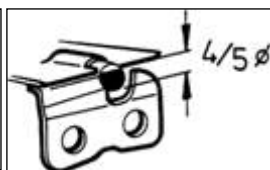
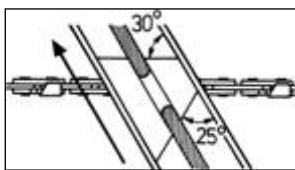

A file holder makes guidance of the file easier, as it has markings for the correct sharpening angle (align the markings parallel to the saw chain) and limits the penetration depth (4/5 of the file diameter)

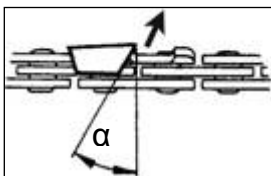

Position the file holder on the roof of the tooth. The file should only engage during the forward stroke. Lift the file off when moving it back.

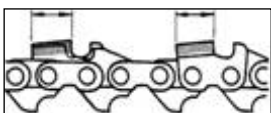

The shortest cutting tooth is sharpened first. The length of this tooth is then the target size for all the other teeth on the saw chain. All of the cutting elements must have the same length.

To start with, file all of the cutting elements on one side from the inside outwards, then file all of the cutting elements on the other side.

Always fully file out any damage from the side plate or the roof of the tooth.

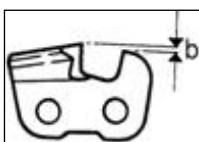

Correction of the depth limiter:

The distance  $b$  between the depth limiter (round nose) and the cutting edge defines the thickness of the chips. The best cutting results are obtained with the prescribed depth limiter spacing, which should be checked every time the saw chain is sharpened.

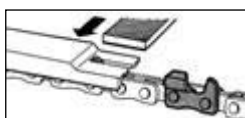

Lay the depth limiter gauge on the cutting element. If the depth limiter protrudes, file off the protruding part with a flat file.

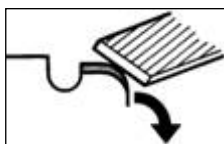

Round off the front edge of the depth limiter. The original shape must be restored.

**CAUTION:** If the spacing is too large then there is a greater risk of kickback.



**For your safety:** If you would like to pull the chain through while filing, pull the chain forwards with a screwdriver towards the tip of the rail. This will reduce the risk of slipping.



**Notes on replacing the saw chain and the sprocket**

If the saw chain becomes too worn then it will become impossible to re-sharpen it properly and it should be replaced.

- ! In this case you should also check the condition of the sprocket. A worn sprocket will cause damage to a brand new saw chain. As a result, you should replace the sprocket together with the chain.
- ! Always install matching components (sprocket, guide rail, saw chain) (see Chapter 9, "Permissible cutting gear and further accessories", page 40).

**Tip:** We recommend the use of two saw chains per sprocket, and that both chains should be replaced as frequently as possible so that all of the components wear evenly. Once a certain wear limit is reached, replace all of the parts together again.

644, 651, 651H, 656, 656H

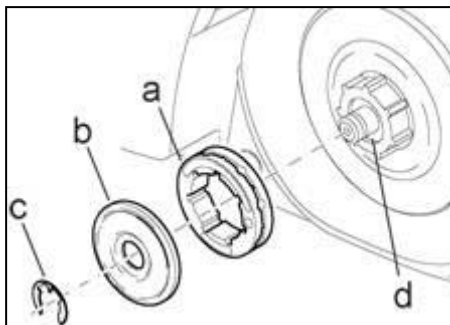

Schematic diagram of components:

- a) Sprocket
- b) Washer
- c) Retaining ring
- d) Bearing

651SP, 656SP

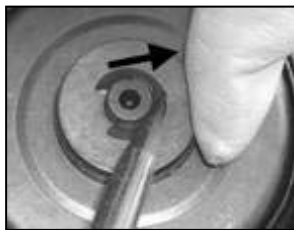
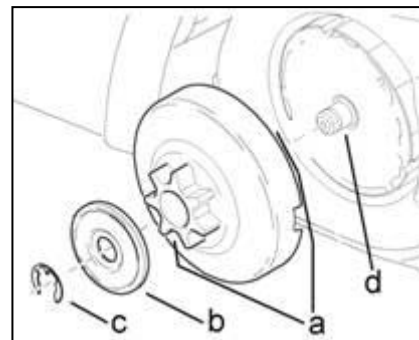

**Replacing the sprocket:**

- Take off the rail cover, saw chain and guide rail (Chapter 4.1),
- use a screwdriver to take off the retaining ring (c), making sure, with your gloves on, that it does not jump off.
- Replace the sprocket,



- ! Whenever you replace the sprocket, lubricate the bearing (d) with lithium-based grease.
- It is best to use flat pliers when refitting the retaining ring.



Please refer to Chapter 4.1, "Installation of the guide rail and saw chain", for more information on fitting a new saw chain.

**Guide bar:**

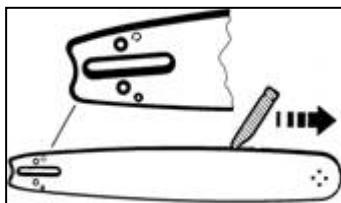

The guide bar of your chainsaw requires just as much care as the saw chain. The running surfaces must be flat and level, and the groove must not be widened. Clean the groove and make sure it is free of all foreign bodies.

In order to prevent one-sided wearing of the guide bar, we recommend that the guide bar be reversed whenever the chain is sharpened.

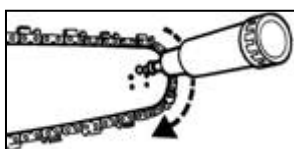

On guide bars with a guide sprocket, the bearing of the guide sprocket should preferably be lubricated with ball bearing grease (through the lubricating hole on the side with a grease gun) every time the chainsaw is refuelled. Rotate the guide sprocket while doing this.



**Important:** The guide bars are only designed to guide the saw chain and must not be used as a levering tool. Any twisting or turning or use of the guide bar to gain leverage in the wood shortens the service life of the guide bars.

## 8.2 Carburettor settings

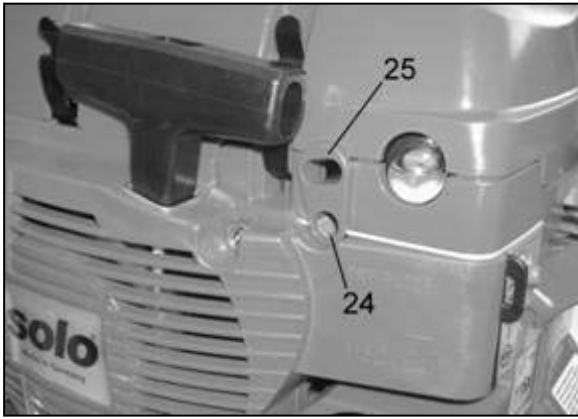

The carburettor is preset to the optimum settings for the device at the factory. Depending on the particular location where the chainsaw is used (mountains, flat country) it may be necessary to adjust the idling settings via the idle stop screw "T" (24).

→ The adjusting screws for the idling mixture "L" and the full-load mixture "H" (25) must only be adjusted by an authorised workshop.

When the idling settings are correct the engine should run smoothly at idle without the saw chain being driven. Corrective adjustments to the average idle speed indicated in the technical data can be made as follows via the idle stop screw "T" – ideally with the aid of a tachometer:

- If the idle speed is too high (particularly if the saw chain is already driven without the throttle being operated), slightly open up the idle stop screw "T" by turning it anti-clockwise.
- If the idle speed is too low (i.e. the engine keeps stopping at idle), slightly close the idle stop screw "T" by turning it clockwise until the engine runs evenly.



The saw chain must never be driven while the engine is idling.

If the idling speed cannot be set correctly with the idling end-stop screw "T", request an authorised service centre to tune the carburettor.

### The following instructions are for authorised service shops

D-CUT carburettors:

- Use the D-CUT carburettor key to adjust the idle mixture screw "L" and the full load mixture screw "H".
- Information about the standard settings can be requested from the specialist workshop of our customer service department or downloaded from our Internet portal for specialist dealers at [www.part-and-more.org](http://www.part-and-more.org).

Carburettors with limiter caps:

- The regulating screws for idle mixture and full load mixture can only be adjusted in a limited range.

Clean the air filter before adjusting the low speed screw!

Let the engine run warm before adjusting the engine speed.

The carburettor is tuned for optimum engine performance. Use a rev counter to tune the carburettor correctly!



Do not adjust the engine to a higher speed. Excessive engine speed can lead to major engine damage!

### 8.3 Maintenance of the air filter



Dirty air filters and pre-filters reduce the power output of the engine. They increase fuel consumption and therefore the pollutants in the exhaust. In addition they also make the starting process more difficult.

If the chainsaw is in all-day use then both air filters (the pre-filter (if equipped) and the main air filter) must be cleaned on a daily basis. It may also be necessary to clean them in between if the level of dust is very high.

Carry out the following maintenance jobs regularly.

ENGINE

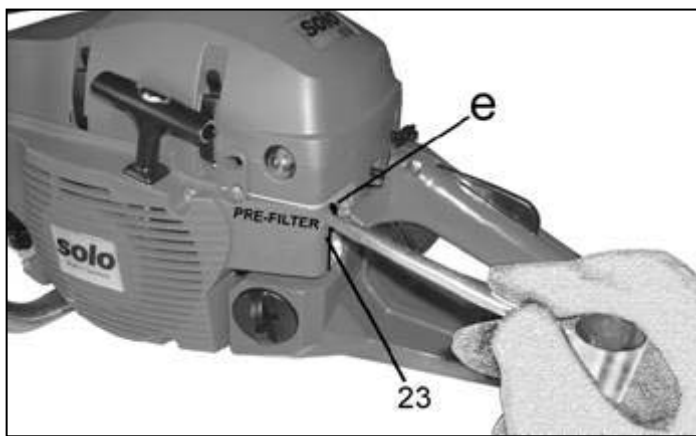

#### Removing the pre-filter

- Position a screwdriver on the protruding tab (e) of the pre-filter and pull out the pre-filter.
- When inserting the pre-filter again afterwards (after cleaning), make sure that the thickened part (lug) on the pre-filter engages in the housing cover (23) on the side.

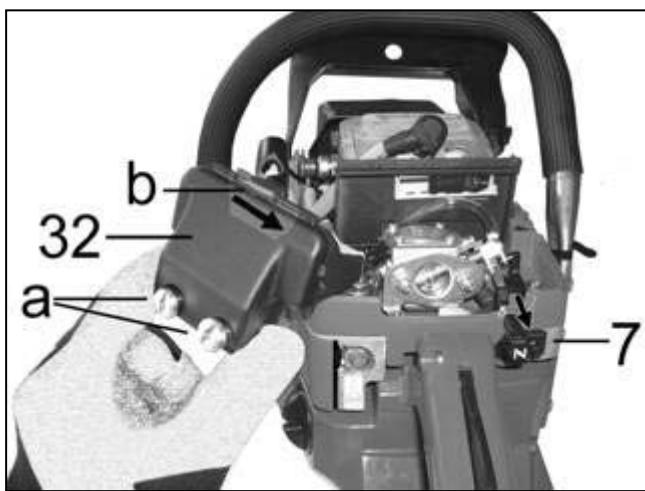

#### Removal of the main air filter

- Take off the cowl of the chainsaw (Chapter 3.4)
- Pull out the choke lever (7).
- Take off the main air filter (32) by undoing the two retaining screws (a).
- To open the main air filter, slide the clamping profile (b) to the side.
- When the main air filter is subsequently refitted (after cleaning), make sure that clean contact is made at the carburettor

- To clean, simply tap out the filter or carefully clean it with compressed air. When using compressed air, always wear suitable eye protection (protective goggles) and do not apply the compressed air too close to the air filter.
- If they are more heavily contaminated, both filters can be cleaned with non-flammable cleaning fluid (warm soapy water).



Both filters must be absolutely dry before they are refitted to the device.



The corresponding parts should be replaced immediately if the filter material is damaged. No warranty claims can be accepted for engine damage arising as a result of inadequate care.

## 8.4 Maintenance of the chain brake



Check for ease of movement and correct operation on a daily basis. Remove any resin, sawdust and dirt.



Grease should be applied to all visible joints and bearings approximately once a week (indicated with arrows in the diagram)



For improved access → activate the chain brake



Chain brake function test (chapter 3.9).

## 8.5 Vibration damping

If you find that vibrations on the handles worsen significantly with time in comparison to when the chainsaw was new, check the damping elements (rubber-bonded metal mountings) for damage and replace them as required.



Working with the chainsaw while the vibration damping system is not working properly can cause health problems.

## 8.6 Spark plug information



The spark plug should be regularly checked every 50 operating hours.

- Take off the cowl from the chainsaw. (chapter. 3.4)
- Disconnect the spark plug connector which is located underneath.
- Unscrew the spark plug and dry it thoroughly.

In the event of severe burn-off of the electrodes the spark plug should be replaced immediately, otherwise every 100 hours.



The engine must not be moved if the spark plug is removed or the ignition cable is disconnected. Otherwise there is a risk that sparks could form which might cause a fire.

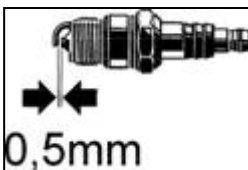

Interference-suppressed replacement spark plugs (calorific value: 200) are available for example under the following trade names:

**BOSCH WSR6F**, **CHAMPION RCJ-6Y** or equivalent.

The prescribed electrode gap is 0.5 mm.

Before starting work, check the ignition cable to make sure the connections are in good working order and the insulation is intact.

- Screw the spark plug back in again.
- Always press the spark plug connector firmly onto the spark plug.
- Refit the cowl to the chainsaw.

## 8.7 Replacing the fuel filter

We recommend having the fuel filter changed annually by a specialised service centre.

A trained mechanic can carefully remove the fuel filter via a wire loop through the fuel tank filler. Ensure that the thicker part of the fuel hose on the tank wall is not drawn into the fuel tank.

### 8.8 Scheduled maintenance

The following information is based on standard operating conditions. For special conditions, such as prolonged daily use, the recommended maintenance intervals should be reduced accordingly.

Implement all maintenance jobs regularly. If required, authorise a specialist service centre to maintain the machine for you. The owner of the machine is responsible for:

- Any damage caused by a lack of maintenance, incorrect or late maintenance and repairs
- Consequential losses - including corrosion - from incorrect storage

		after the first 5 hours	Daily, before and/or after work and also in between	weekly	after every 50 hours	after every 100 hours	as required	Yearly before or after the season
<b>Complete machine</b>	Visual inspection		X					
	Clean (incl. air inlet, cylinder cooling fins)		X				X	X
<b>Guide bar</b>	Visual inspection		X					
	Reverse the blade			X				
	Lubricate the guide sprocket		X					
	Clean the chain groove / oil bore		X					
	Clean the blade cover on the inside		X					
<b>Saw chain</b>	Visually inspect condition, check sharpness		X					
	Re-sharpen						X	X
	Renew, possibly renew the sprocket as well and lubricate the sprocket bearing						X	
<b>Chain brake</b>	Functional test, check for ease of operation		X					
	Clean, lubricate joints			X			X	
<b>Chain lubrication</b>	Check		X					
<b>Silencer</b>	Visual inspection of condition – check tightness of screws/bolts		X					
<b>Carburettor</b>	Check idling speed		X					
	Adjust idling speed						X	
<b>Air filter</b> (pre-filter and main air filter)	Clean		X					
	Replace						X	
<b>Spark plug</b>	Check the electrode gap and adjust, if required				X			X
	Replace					X	X	
<b>Fuel tank, oil tank</b>	Clean				X			X
<b>Fuel filter</b>	Replace							X
<b>All accessible screws</b> (except for adjusting screws)	Retighten	X					X	X
<b>Other control elements *</b>	Funktionsprüfung		X					

\* [stop switch, grip heating (specific models only), throttle control, throttle control lock, choke part throttle stop, starter, sliding switch for winter and normal mode]

## 8.9 Self-help tips

Possible malfunctions: ..... → 

- **The engine will not start**
  - Correct starting settings? (E.g. the stop switch)..... → Kap. 5.2
  - Spark plug?
    - Clean or replace ..... → Kap. 8.6
  - Combustion chamber oversaturated
    - Unscrew the spark plug, dry, vent the combustion chamber.. → Kap. 5.3
  - Old fuel?
    - Drain and clean the tank, refuel with fresh fuel ..... → Kap. 4.3
- **The chain will not run**
  - Chain brake (release when working) ..... → Kap. 3.9
- **The chain is driven at idle**
  - Correctly adjust the idling stop screw "T" ..... → Kap. 8.2
  - Defective clutch
    - Service workshop
- **Poor engine performance**
  - Air filter clogged
    - Clean both filters..... → Kap. 8.3
  - Choke not fully open
    - Press the choke lever right in ..... → Kap. 3.8
  - Carburettor settings ("L" / "H" settings)
    - Service workshop
- **The saw chain is not cutting well**
  - Chain is blunt / incorrectly sharpened
    - Sharpen the chain correctly ..... → Kap. 8.1

## 8.10 Shutdown and storage

The chainsaw should be thoroughly cleaned and checked for damage after every use. The most important areas are the chain brake, the cooling air intake area, the cylinder cooling fins and the air filter. Only use the eco-friendly cleaning agents available from a specialist retailer. Do not use fuel to clean the chainsaw.









*Tip: "SOLO Universal Cleaner" (Order no.: 00 83 116). After a short soaking-in period even the toughest, most baked-on residue can be easily wiped off with a cloth.*

The chainsaw should be stored in a dry room and fitted with a chain guard. There must be no naked flames or similar in the vicinity. Measures must be taken to prevent unauthorised use of the chainsaw, particularly by children.

If you plan to stop using the saw for more than four weeks then you should also drain the fuel tank and the chain lubrication oil tank in a well vented area and clean them. Start the engine with the fuel tank empty and run it until the carburettor is empty and the engine goes out. Otherwise oil residue from the fuel mixture could block the carburettor nozzles and make subsequent starts more difficult.

**Important:** If you are using bio-chainsaw oil and planning to stop using the chainsaw for at least 2 months then you should run the chainsaw for a while with the oil tank filled with engine oil (SAE 30), so that all residue of the bio-oil is flushed from the tank, oil pickup hose and cutting device.

## 9. Permissible cutting gear and further accessories

							
Sprocket		Pitch	Cutting length	Number of driving links	Driving link thickness	Saw chain order no.	Guide rail order no.

Models **651SP, 656SP** - Half bit (half-round cutting tooth) - Code: 21BP... - Pitch .325"

<b>B)</b> <b>.325" - 7</b> No.: 35 00 362 25	.325"	33 cm / 13"	56	.058" / 1,5 mm	69 00 704	69 00 342
	.325"	38 cm / 15"	64	.058" / 1,5 mm	69 00 875	69 00 343
	.325"	46 cm / 18"	72	.058" / 1,5 mm	69 00 884	69 00 861

Models **644, 651, 651H, 656, 656H** - Half bit (half-round cutting tooth) - Code: 21BP... - Pitch .325"

<b>A)</b> <b>.325" - 7</b> No.: 30 38 420	.325"	33 cm / 13"	56	.058" / 1,5 mm	69 00 704	69 00 500
	.325"	38 cm / 15"	64	.058" / 1,5 mm	69 00 875	69 00 464
	.325"	46 cm / 18"	72	.058" / 1,5 mm	69 00 884	69 00 465

Models **644, 651, 651H, 656, 656H** - Solid bit (rectangular cutting tooth) - Code: 21LP... - Pitch .325"

<b>A)</b> <b>.325" - 7</b> No.: 30 38 420	.325"	33 cm / 13"	56	.058" / 1,5 mm	69 00 682	69 00 500
	.325"	38 cm / 15"	64	.058" / 1,5 mm	69 00 871	69 00 464
	.325"	46 cm / 18"	72	.058" / 1,5 mm	69 00 889	69 00 465

Models **656, 656H** - Solid bit (rectangular cutting tooth) - Code: 73LP... - Pitch .3/8"

<b>A)</b> <b>3/8" - 7</b> No.: 30 38 377	3/8"	40 cm / 16"	60	.058" / 1,5 mm	69 00 872	69 00 466
	3/8"	45 cm / 18"	64	.058" / 1,5 mm	69 00 887	69 00 742
	3/8"	50 cm / 20"	72	.058" / 1,5 mm	69 00 874	69 00 467

Models **656, 656H** - Half bit (half-round cutting tooth) - Code: 73D,DP... - Pitch .3/8"

<b>A)</b> <b>3/8" - 7</b> No.: 30 38 377	3/8"	40 cm / 16"	60	.058" / 1,5 mm	69 00 434	69 00 466
	3/8"	45 cm / 18"	64	.058" / 1,5 mm	69 00 443	69 00 742
	3/8"	50 cm / 20"	72	.058" / 1,5 mm	69 00 436	69 00 467

 **Important:** Only use the specified combination of **sprocket, saw chain** and **guide rail**. Never combine components with a different pitch!

The next three pages are abbreviated extracts from our general 2007 catalogue. If you require a copy of the full catalogue, please contact your specialist SOLO dealer or visit our website at [www.solo-germany.com](http://www.solo-germany.com).



# SOLO

## Chainsaw accessories – for excellent results



Product	Description	Part no.
	<b>Chain oil</b>	
	1 l bottle	00 83 189
	5 l container	00 83 185
	20 l container	00 83 186
	55 l barrel	00 83 187
	200 l barrel	00 83 188
	<b>BIO saw chain oil, biologically degradable</b>	
	1 l bottle	00 83 107
	5 l container	00 83 108
	20 l container	00 83 109
	55 l barrel	00 83 112
	200 l barrel	00 83 114
	<b>SOLO Professional 2-stroke engine oil</b>	
	SOLO Professional 2-stroke engine oil, 100 ml	00 83 103
	SOLO Professional 2-stroke engine oil	00 83 104
	SOLO Professional 2-stroke engine oil, 1 l bottle	00 83 105
<b>CASTROL SUPER TT</b> Not shown	<b>Special two-stroke oil</b> <b>CASTROL SUPER TT:</b> Bottle, 1 l with scale	00 83 135
	Universal cleaner, 500 ml	00 83 116
	Universal cleaner, 10 l	00 83 117
	Maintenance/servicing oil	00 83 163
	Anti-corrosion oil	00 83 142
	<b>Grease gun</b> for sprocket nose guide bar	00 80 430
	<b>Mixing can, 1 l</b> with filler and cap	27 00 278
	Carry-bag for motorised saw (without saw)	6900793001

Product	Description	Part no.
	Transport box for motorised saw (without saw)	69 00 791
	<b>Metal saw horse</b> (without saw)	69 00 200
	Electric chain sharpener "Jolly" 220V	60 00 206
	<b>Manual file guide</b> without file	60 00 200
	<b>Chain rivet breaker</b> for punching chain rivets	60 00 207
	<b>Riveter</b> for riveting chains	60 00 208
	<b>Round chain file</b>	
	Ø 4.0 mm for 1/4" and 3/8" spec.	00 80 358
	Ø 4.5 mm for .325"	00 80 431
	Ø 4.8 mm for .325" and 3/8" spec.	00 80 287
	Ø 5.5 mm for 3/8" and .404"	00 80 109
	<b>File holder</b>	
	With 4 mm file for 3/8" and 1/4" chains	00 80 447
	With 4.5 mm file for .325" chains	00 80 448
	With 4.8 mm file for .325" chains	00 80 449
	With 5.5 mm file for 3/8" and .404" chains	00 80 450
	<b>File wallet</b>	00 80 108

# SOLO

## Protective and practical clothing



1 This fashionably styled **professional forestry work jacket** provides effective protection against cold wind and light rain. Its robust, breathable stretch material offers maximum freedom of movement. The professional jacket is available in sizes S, M, L, XL.

2 **Professional rip-proof trousers** with braces made out of stretch material TG611, 90% Nylon, 10 % Spandex, 205 g/m<sup>2</sup>, provide maximum breathability in addition to maximum tear resistance according to ISO 13937 and stretch according to ISO13934 in warp and weft. With maximum wearing comfort and innovative applications such as inner belt system, padded tool pocket with magnet closure, waterproof zips, knee reinforcements, various pockets, elasticised crotch, ventilation zips, and many more features, these professional trousers set new standards in terms of quality and comfort! Tear resistance category 1 EN 81. Sizes S, M, L, XL.

3 **Fibre fur jacket signal red**  
Helly Hansen fibre fur jacket to EN 342 with FPA recognition and recommen-

dation by the KWF (tested version Helly Hansen 91-262). Ideal insulation and moisture removal properties make this jacket the perfect clothing for all work in cold or wet conditions.

4 This modern **forestry and farm work jacket** – EN 340 – is made of extremely robust Cordura (tear resistant to approx. 120 kg in warp and weft) in breathable linen weave with water-repellent Teflon coating on the shoulders. The raglan cut offers maximum freedom of movement and has a closable back vent. The back section is extended and fitted with a first-aid pocket. The inside of the collar is lined with soft fleece. The front zip fastener has a Velcro cover. Two breast pockets with Velcro closures and an integrated mobile phone pocket, two side pockets with zip fastenings and inset pockets with Velcro fastening guarantee lots of storage. The sleeves have elasticised cuffs and net-lining for ventilation under the arms. The jacket is available in sizes S, M, L, XL, XXL.

5 **Safety trousers with braces** – EN 381 Class 1 made of lightweight and extremely robust Cordura fabric (tear resistant to approx. 120 kg in warp and

weft) in a breathable linen weave. They have waterproof, Teflon-coated reinforced knee sections, netbacked vents at the back, an elastic insert in the crotch and lightweight elastication in the high back. Both back pockets have press-stud closures, and the trousers also have a key pocket and a reinforced tape measure pocket. The trousers are available in sizes 44 - 60, 94, 98, 102, 106, 110.

Also available as **safety trousers with bib** – EN 381 Class 1. (Not illustrated).





These robust **professional forestry safety boots with category 1 tear resistance** are manufactured according to traditional methods with special protective gaiter construction: the stable, tear-resistant outer flap fully covers an additional inner flap, over the instep and the entire shin. This has the advantage of increased tear resistance, and additionally improved protection against moisture and water penetration. The vegetable tanned, full-grained calf leather is antistatic, breathable and authentically double-stitched from one seamless piece. The safety construction has a breathable comfort sole and a soft nappa leather lining, soft collar and flap padding, a steel toe cap and a pierce-resistant, shock-absorbing, slip-resistant sole. Weight 2800g/pair, bootleg height 18cm, width 10, sizes 39 - 47



- 1 **Splitter axe** Professional quality, head weight 1250 g, 50 cm long ash handle 10 cm wide cut, special wide head.
- 2 **Tyrollean wedge axe** Ash handle, highest quality materials and workmanship, head weight 2750 g, handle length 85 cm. Cut width 12 cm.
- 3 **Wedge hammer** The right partner for heavy splitting work in wood and forest. Head weight 3000 g. Ash handle 85 cm, cut width 8 cm.



1 **Professional forestry gloves** from Keiler Forst, with integrated leather pulse protection and knitted band, strong non-tanned grainy calf leather, red, water-repellent screen silk backs, 3 sizes

2 **SOLO Fit safety gloves:** In soft kid, reinforced palm, nylon/spandex backs, elastic velcro fastener with optimal sense of touch. Elastic size 10 and 12,5

3 These **extra wide braces** offer added comfort and fasten with buckles.

4 **Safety helmet Peltor** helmet combinations provide effective protection for eyes, ears and face and meet the new requirements of European standard EN 397:1995. The helmet is made of newly developed UV-stable ABS plastic, which is extremely stable, robust and very light. One size



**Outdoor trousers with braces** – whatever you are doing, these trousers will be up to the job. Two strong side pockets. Two back pockets, a pocket for a tape measure and a thigh pocket, knee padding pockets and hammer loop – these trousers have got it all. The trousers convert into practical shorts by removing the Velcro-fastened legs at the knees. Available in all standard sizes. 65 % polyester, 35 % cotton, weight: 300 g/m<sup>2</sup>, washable up to 60 °C.

**Outdoor trousers with bib** – Mobile phone pocket, reflective strips, back pockets (one with flap, one with Velcro fastening), 2 tape measure pockets, hammer loop or thigh pocket with flap, fully equipped trousers. The knee padding pockets are protective even without padding, but can be padded when required. The waistband is adjustable, as are the high-quality braces, and the belt loops are ideal for attaching multipurpose tools. Sizes and fabrics as for standard trousers.

**Leather forestry boots** of exceptional quality with a top price / performance ratio. Black waterproof leather, nappa leather lining, ankle and collar padding, padded flap, riveted, closed eyelets, hooks and eyes, sewn and stuck upper toe cap, permanently anatomically moulded foot support with changeable inlay, flex zone in the heel area, foam material-packed 6 mm profile PU/rubber sole, weight approx. 1.190 grams, sizes 36 - 47

HRO / EN 381



## 10. Parts subject to wear and tear

Various parts are subject to application-specific or normal wear and must be replaced in good time, when required. The following parts are subject to normal wear and are not covered by the manufacturer's guarantee:

- Air filter
- Fuel filter
- All rubber parts which come into contact with fuel
- Clutch
- Spark plug
- Starter
- Cutting tools
- Operating materials
- Cutting tools: guide bar / saw chain
- Vibration damping elements made of rubber

## 11. Guarantee

The manufacturer guarantees trouble-free quality and will cover the cost of replacing parts which are found to be faulty in material or workmanship within the prescribed guarantee period after the date of purchase. Please note that specific guarantee conditions may vary from country to country. If in doubt, ask your equipment vendor. He is responsible for guarantee matters.

We hope you will understand that we cannot be liable for damage resulting from the following causes:

- Non-compliance with the operating instructions.
- Neglecting essential maintenance and repair work.
- Damage caused by incorrect carburettor adjustment.
- Wear in normal use.
- Obvious overload by continuously exceeding the maximum performance limit of the product.
- Using non-authorised tools.
- Use of force, incorrect treatment, misuse and accidents.
- Damage from excessive heat due to dirt build-up around the cooling fan housing.
- Attempted adjustments and repairs by unqualified persons.
- Use of unsuitable spare parts or third party parts, if these are the cause of the defect.
- Use of unsuitable or stale fuel.
- Damage caused by using the product in the hire or rental industry.

Normal cleaning, adjustments or maintenance work fall outside the guarantee provisions.

A service centre authorised by the manufacturer must carry out all guarantee work.

**12. CE Declaration of conformity**

In accordance with EG Directives 98/37/EC, 2000/14/EC and RL - 2004 - 108 EC, SOLO Kleinmotoren GmbH, Stuttgarter Strasse 41, D-71069 Sindelfingen, being solely responsible, states that the product referred to in this declaration complies with the requirements of the Machinery Directive.

Description of product:	chain saw			
Model/type description:	644	651 / 65SP / 651H	656 / 656SP / 656H	
Sound power level (EN ISO 3744, Guaranteed sound EN ISO 22868) Actual sound	116 114	116 115	116 115	dB(A) dB(A)

Applied standards: DIN EN ISO 11681, DIN EN 14982  
 Conformity assessment procedures (2000/14/EG) → Appendix V  
 Nominated location acc. to 98/37/EC : Intertek Deutschland GmbH  
 Nikolaus-Otto-Str. 13  
 D 70771 Leinfelden-Echterdingen  
 Registration number. 0905

Storage location for the technical documentation according to 2000/14/EC and 89/336/EC: Solo Kleinmotoren GmbH  
 Stuttgarterstr. 41  
 D-71069 Sindelfingen

Serial number, Build year → Type plate

This declaration of conformity loses its validity, if the equipment is converted or modified without the manufacturer's consent.

Sindelfingen, 1<sup>st</sup> August 2007  
 SOLO Kleinmotoren GmbH

  
 Wolfgang Emmerich  
 Executive Director

**13. For USA only: ECW Statement / Manufacturers Warranty Coverage**

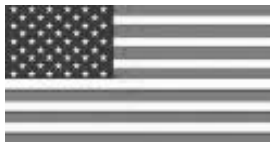

For USA only

**Emissions Control Warranty Statement**

The Environmental Protection Agency and Solo are pleased to explain the emission control system on your small non-road power equipment engine. In the US new small non- road engines must be designed, built, and equipped to meet the Environmental Protection Agency's standards. Solo must warrant the emission control system on your small non- road engine for the period of time listed below provided there has been no abuse, neglect, or improper maintenance of your small non-road engine. Your emission control system includes parts such as the carburetor, the ignition system, and the exhaust system.

Where a warrantable condition exists, Solo will repair your small non-road power equipment engine at no cost to you including diagnosis, parts, and labor.

**Manufacturers Warranty Coverage**

Solo's small non-road power equipment engines are warranted for a period of two years. If any emission control related part on your engine is defective, the part will be repaired or replaced by Solo.

Contact Information for Authorized Service Center Locations, Replacement Parts,

Warranty and Technical Information

Warranty repairs **must** be completed by a SOLO Authorized Service Center.

SOLO USA, Inc. 1-800-765-6462  
 5100 Chestnut Avenue techserv@solousa.com  
 Newport News, VA 23605

# **solo**<sup>®</sup>

Made in Germany



**SOLO**  
Postfach 60 01 52  
D 71050 Sindelfingen  
  
Tel. 07031-301-0  
Fax 07031-301-130  
[info@solo-germany.com](mailto:info@solo-germany.com)

**SOLO**  
P.O.Box 60 01 52  
D 71050 Sindelfingen  
Germany  
Phone+49-7031-301-0  
Fax +49-7031-301-149  
[export@solo-germany.com](mailto:export@solo-germany.com)